



Loft Solo

REGALSYSTEM

SHELVING SYSTEM

Regalsystem
Shelving system

PRELISTE/PRICE LIST

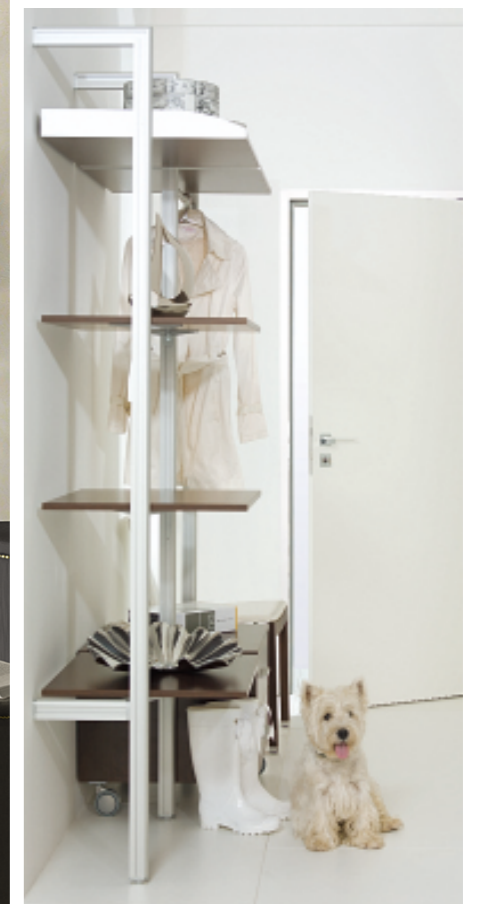

Loft Solo Regal-und Schranksystem bietet Lösungen für eine attraktive und optimale Gestaltung von Wohnräumen, Büros, Garderoben, Esszimmern, Vorzimmern oder Bädern. Für alle, die in Ihren Wohnräumen klares Design haben möchten. | *Loft Solo is a solution for living room, wardrobe, office, lounge or bathroom for those, who want contemporary interior design furniture in their homes.*



PROFILFARBEN | PROFILE COLORS



AL1 - NATUR MATT ELOXIERT
AL1 - NATURAL MATT ANODISED

W RAL 9003 - WEISS
W RAL 9003 - WHITE

A - ANTHRAZIT MATT ELOXIERT
A - ANTHRACITE MATT ANODISED

STANDARD MÖBELFARBEN | STANDARD FURNITURE COLORS



WEISS
WHITE

MORIER
MORIER

MILANO NUSS
MILANO NUT

BIRKE
BIRCH

WEITERE MÖBELFARBEN AUF ANFRAGE | OTHER
FURNITURE COLOURS ON REQUEST

GLÄSER FÜR ALU-RAHMEN |
GLASS FOR ALU-FRAMES



PURE WEISS
PURE WHITE

HELLBRAUN
LIGHT BROWN

PROFIL FÜR ALU-RAHMEN |
PROFILE FOR ALU-FRAMES



PROFIL | PROFILE SAS877
OBERFLÄCHE | FINISH AL1
ÖFFNUNG | OPENING PUSH-OPEN



ALLES, WAS SIE BENÖTIGEN

BEI EINER GUT GEPLANTEN GARDEROBE KANN DER ZUR VERFÜGBAR STEHENDE RAUM PERFEKT AUSGENUTZT WERDEN. ZUR OPTIMALEN GESTALTUNG SOLLTEN DIE VIELFALT BZW. MENGE DER KLEIDUNGEN UND DIE ART & WEISE DER AUFBEWAHRUNG BERÜCKSICHTIGT WERDEN. LOFT SOLO GIBT MAXIMALE MÖGLICHKEIT FÜR INDIVIDUALITÄT.

EVERYTHING YOU COULD POSSIBLY NEED...

A PERFECTLY DESIGNED WARDROBE WILL MAKE THE BEST USE OF THE SPACE AVAILABLE. KEY ASPECTS OF WARDROBE DESIGNS - BESIDES THE VOLUME AND VARIETY OF CLOTHING IT IS SUPPOSED TO ACCOMMODATE- SHOULD BE THE SYSTEM ACCORDING TO WHICH YOU WANT TO STORE THEM AND THE FUNCTIONALITY OF THE STORAGE FACILITY. FORTUNATELY OUR LOFT SOLO SYSTEM WILL MEET ALL YOUR NEEDS AND EXPECTATIONS.



	ARTIKELLISTE	LIST OF ARTICLES	STK PC	SEITE PAGE
V2F2750X285 AL1	GP2 F-SÄULE	GP2 F-FRAME	7	86
LS2L AL1	HOLZBODENTRÄGER	WOOD SHELF HOLDER	21	98
HSSR-5553	HOLZBODEN 900MM	WOOD SHELF 900MM	11	100
HSSR-5550	HOLZBODEN 550MM	WOOD SHELF 550MM	10	100
RH900V	KLEIDERLIFT 900MM	LIFT-UP CLOTHES ROD 900MM	2	110
LSKS 900 AL1	KLEIDERSTANGE 900MM	CLOTHES ROD 900MM	2	109
LS2KL	KORPUSHALTER (FÜR SCHUHHALTER, HOSENHALTER UND KRAWATTENHALTER)	BOX HOLDER (FOR SHOE RACK, TROUSERS RACK AND TIE HOLDER)	3	105
KN900A	AUSZIEHBARER HOSENHALTER	PULL-OUT TROUSERS RACK	1	111
KC900A	AUSZIEHBARER SCHUHHALTER	PULL-OUT SHOE RACK	1	112
KNYA900A	AUSZIEHBARER KRAWATTENHALTER	PULL-OUT TIE HOLDER	1	112
HSSR-4417PP-LB9	KORPUS MIT 3 SCHUBLADEN MIT GLASFRONT IN ALU-RAHMEN (550 x 607 MM)	BOX WITH 3 DRAWERS WITH GLASS FRONT IN ALUMINIUM FRAME (550 x 607 MM)	1	107
HSSR-4434PP-LB9	KORPUS MIT 3 SCHUBLADEN MIT GLASFRONT IN ALU-RAHMEN (900 x 607 MM)	BOX WITH 3 DRAWERS WITH GLASS FRONT IN ALUMINIUM FRAME (900 x 607 MM)	1	107

VIELE KLEIDER ZUM AUFHÄNGEN | LOTS OF HANGING SPACE



	ARTIKELLISTE	LIST OF ARTICLES	STK PC	SEITE PAGE
V2F2750X285 AL1	GP2 F-SÄULE	GP2 F-FRAME	3	86
LSY	HOLZBODENTRÄGER	WOOD SHELF HOLDER	5	97
HSSR-5553	HOLZBODEN (900 MM)	WOODEN SHELF (900 MM)	5	100
LS2KL	KORPUSHALTER (FÜR HOSENHALTER)	BOX HOLDER (FOR TROUSERS RACK)	1	105
KN900A	AUSZIEHBARER HOSENHALTER	PULL-OUT TROUSERS RACK	1	111
RH900V	KLEIDERLIFT 900 MM	LIFT-UP CLOTHES ROD 900 MM	1	110
LSKS 900 AL1	KLEIDERSTANGE 900 MM	CLOTHES ROD 900 MM	1	109

EIN BISSCHEN VON ALLEM | A BIT OF EVERYTHING



	ARTIKELLISTE	LIST OF ARTICLES	STK PC	SEITE PAGE
V2F2750X285 AL1	GP2 F-SÄULE	GP2 F-FRAME	3	86
LSY	HOLZBODENTRÄGER	WOOD SHELF HOLDER	4	97
HSSR-5553	HOLZBODEN (900 MM)	WOODEN SHELF (900 MM)	4	100
RH900V	KLEIDERLIFT 900MM	LIFT-UP CLOTHES ROD 900MM	1	110
LSKS 900 AL1	KLEIDERSTANGE 900MM	CLOTHES ROD 900MM	1	109
HSSR-4434PP-LB9	KORPUS MIT 3 SCHUBLADEN MIT GLASFRONT IN ALU-RAHMEN (900 x 607 MM)	BOX WITH 3 DRAWERS WITH GLASS FRONT IN ALUMINIUM FRAME (900 x 607 MM)	1	107
SSS-5555-2	ROLLER SET	ROLLER SET	1	105

REGALE - SO VIEL WIE MÖGLICH | PLENTY OF SHELVING



	ARTIKELLISTE	LIST OF ARTICLES	STK PC	SEITE PAGE
V2F2750X285 AL1	GP2 F-SÄULE	GP2 F-FRAME	3	86
LS2L	HOLZBODENTRÄGER	WOOD SHELF HOLDER	7	98
HSSR-5553	HOLZBODEN (900 MM)	WOODEN SHELF (900 MM)	7	100
LSKS 900 AL1	KLEIDERSTANGE 900 MM	CLOTHES ROD 900 MM	1	109
HSSR-4434PP-LB9	KORPUS MIT 3 SCHUBLADEN MIT GLASFRONT IN ALU-RAHMEN (900 x 607 MM)	BOX WITH 3 DRAWERS WITH GLASS FRONT IN ALUMINIUM FRAME (900 x 607 MM)	1	107
SSS-5555-2	ROLLER SET	ROLLER SET	1	105

ALLES AM PLATZ...

ES GIBT KEIN CHARMANTERES MÖBEL, ALS EIN REGAL VOLLER BÜCHER. DIE IDEALEN LÖSUNGEN VON **LOFT SOLO** MIT KLAREM DESIGN BIETEN PLATZ FÜR DIE BÜCHER UND DEKORATIONEN UND DADURCH KANN DAS SYSTEM ZU EINEM MASSGEBLICHEN ELEMENT IHRES WOHNZIMMERS WERDEN.

EVERYTHING HAS ITS PLACE...

NO FURNITURE LOOKS MORE CHARMING, THAN A BOOKSHELF FULL OF BOOKS. OUR **LOFT SOLO** CAN BECOME A DISTINCTIVE PIECE IN YOUR LIVING ROOM WITH ITS MINIMALIST DESIGN AND UNIQUE SOLUTIONS FOR ALL YOUR BOOKS AND DECORATIVE ITEMS



	ARTIKELLISTE	LIST OF ARTICLES	STK PC	SEITE PAGE
V2F2250X285 AL1	GP2 F-SÄULE	GP2 F-FRAME	6	86
LS2L AL1	HOLZBODENTRÄGER	WOOD SHELF HOLDER	16	98
HSSR-5553	HOLZBODEN 900MM	WOOD SHELF 900MM	2	100
HSSR-5550	HOLZBODEN 550MM	WOOD SHELF 550MM	12	100
HSSR-5551	HOLZBODEN 1320MM	WOOD SHELF 1320MM	2	100
LS2KL	KORPUSHALTER	BOX HOLDER	2	105
HSSR-4409	KORPUS WITH FACHTEILUNG 900MM	BOX WITH SECTIONS 900MM	2	108
HSSR-4434PP-LB9	KORPUS MIT 3 SCHUBLADEN MIT GLASFRONT IN ALU-RAHMEN (900 x 607 MM)	BOX WITH 3 DRAWERS WITH GLASS FRONT IN ALUMINIUM FRAME (900 x 607 MM)	2	107

BEQUEM ARBEITEN

FLEXIBLE ZEITEINTEILUNG, PERFEKTE EFFIZIENZ. – DAS **LOFT SOLO** REGALSYSTEM BIETET IHNEN MIT SEINEN VERNÜNFTIGEN ACCESSOIRES ANPASSUNGSFÄHIGE UND BEQUEME LÖSUNGEN FÜR BÜROEINRICHTUNG UND ENTSPRICHT DER HERAUSFORDERUNGEN DES 21. JAHRHUNDERTS.

WORK AND COMFORT

FLEXIBLE SCHEDULE, MAXIMUM PRODUCTIVITY – OUR **LOFT SOLO** SYSTEM PROVIDES A FLEXIBLE AND CONVENIENT SOLUTION FOR YOUR OFFICE WITH ITS SMART ACCESSORIES KEEPING UP WITH THE CHALLENGES OF THE 21ST CENTURY

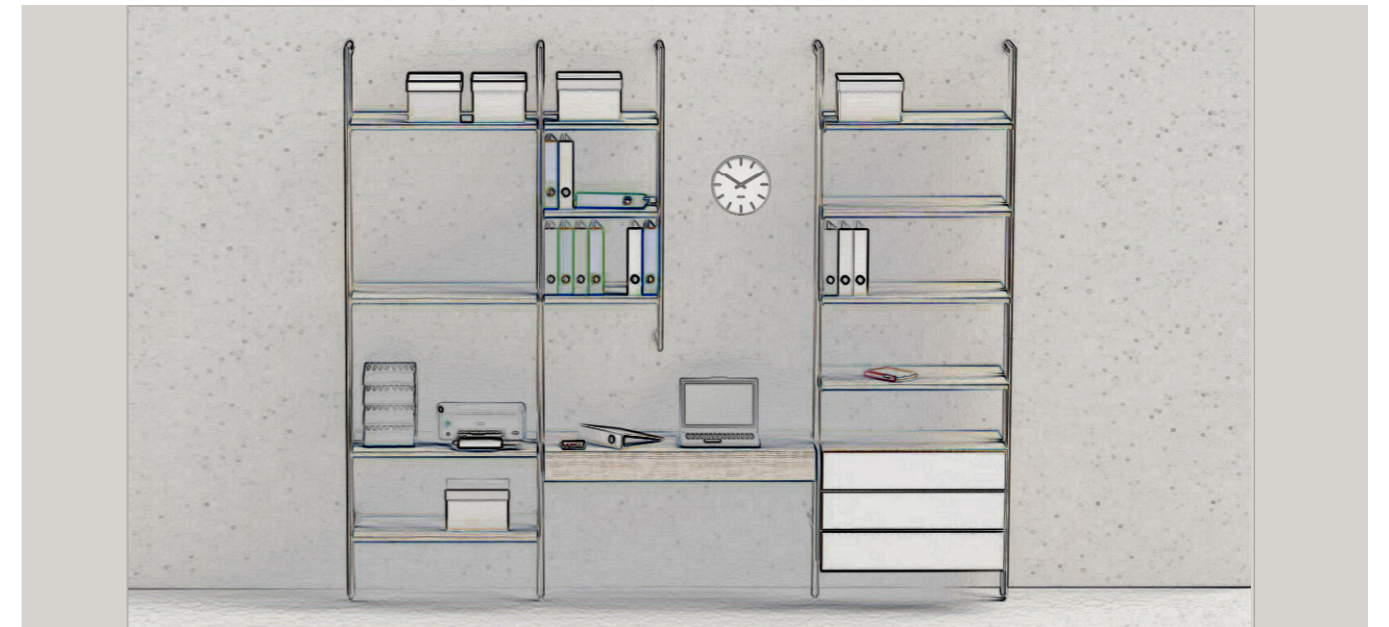

	ARTIKELLISTE	LIST OF ARTICLES	STK PC	SEITE PAGE
V2F2750X285 AL1	GP2 F-SÄULE	GP2 F-FRAME	4	86
V2C1500x285 AL1	GP2 C-SÄULE	GP2 C-FRAME	1	95
LS2L AL1	HOLZBODENTRÄGER	WOOD SHELF HOLDER	11	98
HSSR-5553	HOLZBODEN 900MM	WOOD SHELF 900MM	8	100
HSSR-5550	HOLZBODEN 550MM	WOOD SHELF 550MM	3	100
LS2KL	KORPUSHALTER	BOX HOLDER	2	105
HO1320	HOME OFFICE TISCH MIT SCHUBLADEN 1320 MM	HOME OFFICE DESK WITH DRAWER 1320 MM	1	113
HSSR-4434PP-LB9	KORPUS MIT 3 SCHUBLADEN MIT GLASFRONT IN ALU-RAHMEN (900 x 607 MM)	BOX WITH 3 DRAWERS WITH GLASS FRONT IN ALUMINIUM FRAME (900 x 607 MM)	1	107

GP2 F-SÄULE | GP2 F-FRAME

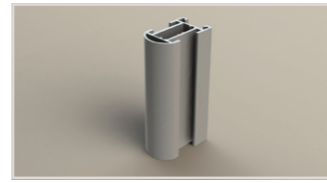
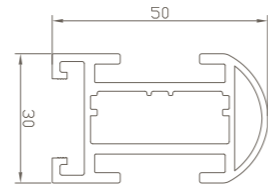

STANDARD OBERFLÄCHEN | STANDARD FINISHES



AL1 – NATUR MATT ELOXIERT
AL1 – NATURAL MATT ANODISED

OBERFLÄCHE COLOR	ART.NR.	MM BxTxH MM WxDxH
AL1	V2F2250x285 AL1	30x285x2250
	V2F2750x285 AL1	30x285x2750
	V2F3000x285 AL1	30x285x3000

i AUCH IN INDIVIDUELLEN GRÖSSEN VERFÜGBAR, STANDARD SÄULENTIEFE IST FÜR 500 MM MÖBELTIEFE OPTIMAL | ALSO AVAILABLE IN INDIVIDUAL SIZES, BUT STANDARD DEPTH OF THE SECTION IS OPTIMIZED FOR 500 MM FURNITURE DEPTH

BESTELLUNG VON INDIVIDUELLER HÖHE | ORDERING OF UNIQUE HEIGHT

- BESTELLUNG MIT INDIVIDUELLER HÖHE MÖGLICH | ALSO WITH UNIQUE HEIGHT AVAILABLE
- WÄHLEN SIE DIE ARTIKEL NR. FÜR GRÖßERE HÖHE | CHOOSE THE ITEM CODE FOR HIGHER FRAME
- FÜGEN SIE „-T:[HÖHE IN MM]“ BEI | ADD „-T:[INDIVIDUAL HEIGHT IN MM]“
- ZB. V2F3000X285 AL1 - T:2950 | E.G. V2F300X285 AL1 - T:2950
- PREIS IST GLEICH ZUM PREIS DES GRÖßEREN ELEMENTS | PRICE EQUALS TO THE PRICE OF THE HIGHER ITEM

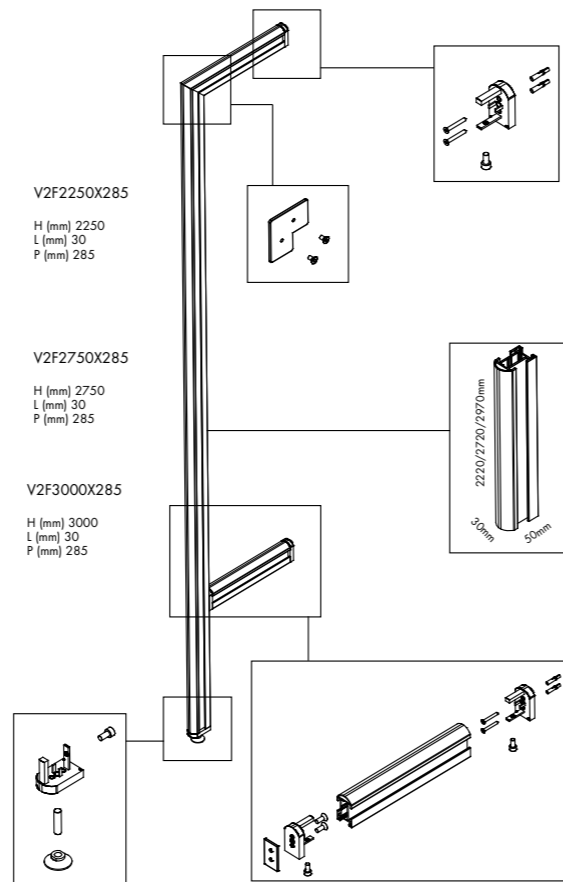

GP2 L-SÄULE | GP2 L-FRAME

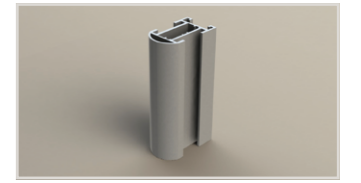
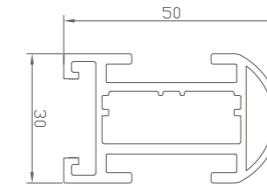

STANDARD OBERFLÄCHEN | STANDARD FINISHES



AL1 – NATUR MATT ELOXIERT
AL1 – NATURAL MATT ANODISED

OBERFLÄCHE COLOR	ART.NR.	MM BxTxH MM WxDxH
AL1	V2L2250X285 AL1	30x285x2250
	V2L2750X285 AL1	30x285x2750
	V2L3000X285 AL1	30x285x3000

i AUCH IN INDIVIDUELLEN GRÖSSEN VERFÜGBAR, STANDARD SÄULENTIEFE IST FÜR 500 MM MÖBELTIEFE OPTIMAL | ALSO AVAILABLE IN INDIVIDUAL SIZES, BUT STANDARD DEPTH OF THE SECTION IS OPTIMIZED FOR 500 MM FURNITURE DEPTH

BESTELLUNG VON INDIVIDUELLER HÖHE | ORDERING OF UNIQUE HEIGHT

- BESTELLUNG MIT INDIVIDUELLER HÖHE MÖGLICH | ALSO WITH UNIQUE HEIGHT AVAILABLE
- WÄHLEN SIE DIE ARTIKEL NR. FÜR GRÖßERE HÖHE | CHOOSE THE ITEM CODE FOR HIGHER FRAME
- FÜGEN SIE „-T:[HÖHE IN MM]“ BEI | ADD „-T:[INDIVIDUAL HEIGHT IN MM]“
- ZB. V2F3000X285 AL1 - T:2950 | E.G. V2F300X285 AL1 - T:2950
- PREIS IST GLEICH ZUM PREIS DES GRÖßEREN ELEMENTS | PRICE EQUALS TO THE PRICE OF THE HIGHER ITEM

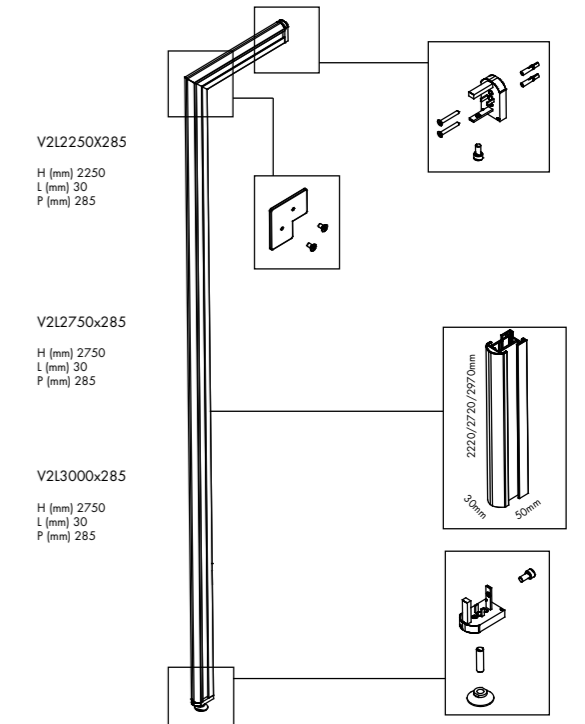

GP3 F-SÄULE | GP3 F-FRAME

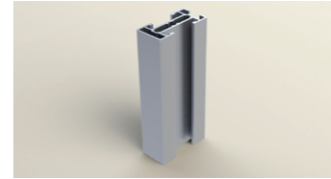
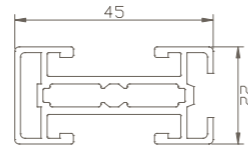
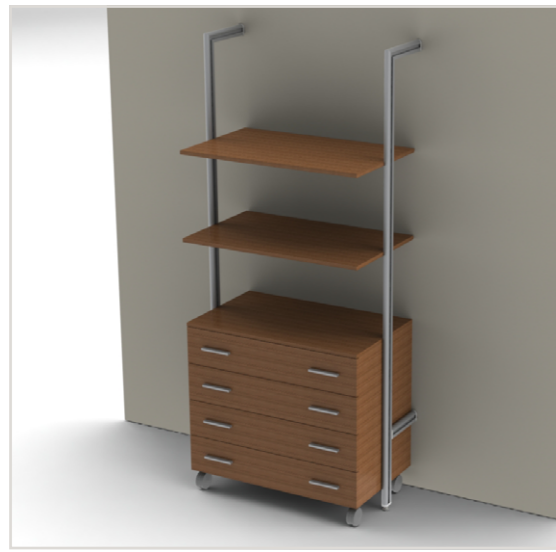

STANDARD OBERFLÄCHEN | STANDARD FINISHES



AL1 – NATUR MATT ELOXIERT
AL1 – NATURAL MATT ANODISED



W RAL 9003 WEISS LACKIERT
W RAL 9003 WHITE LAQUERED



A – ANTHRAZIT MATT ELOXIERT
A – ANTHRACITE MATT ANODISED

OBERFLÄCHE COLOR	ART.NR.	MM BxTxH MM WxDxH
AL1	V3F2250X280 AL1	22x280x2250
	V3F2750X280 AL1	22x280x2750
	V3F3000X280 AL1	22x280x3000
W RAL 9003	V3F2250X280 W	22x280x2250
	V3F2750X280 W	22x280x2750
	V3F3000X280 W	22x280x3000
A	V3F2250X280 A	22x280x2250
	V3F2750X280 A	22x280x2750
	V3F3000X280 A	22x280x3000

i AUCH IN INDIVIDUELLEN GRÖSSEN VERFÜGBAR, STANDARD SÄULENTIEFE IST FÜR 500 MM MÖBELTIEFE OPTIMAL | ALSO AVAILABLE IN INDIVIDUAL SIZES, BUT STANDARD DEPTH OF THE SECTION IS OPTIMIZED FOR 500 MM FURNITURE DEPTH

BESTELLUNG VON INDIVIDUELLER HÖHE | ORDERING OF UNIQUE HEIGHT

- BESTELLUNG MIT INDIVIDUELLER HÖHE MÖGLICH | ALSO WITH UNIQUE HEIGHT AVAILABLE
- WÄHLEN SIE DIE ARTIKEL NR. FÜR GRÖßERE HÖHE | CHOOSE THE ITEM CODE FOR HIGHER FRAME
- FÜGEN SIE „-T:[HÖHE IN MM]“ BEI | ADD „-T:[INDIVIDUAL HEIGHT IN MM]“
- ZB. V2F3000X285 AL1 - T:2950 | E.G. V2F300X285 AL1 - T:2950
- PREIS IST GLEICH ZUM PREIS DES GRÖßEREN ELEMENTS | PRICE EQUALS TO THE PRICE OF THE HIGHER ITEM

V3F2250X280
H (mm) 2250
L (mm) 22
P (mm) 280

V3F2750X280
H (mm) 2750
L (mm) 22
P (mm) 280

V3F3000X280
H (mm) 3000
L (mm) 22
P (mm) 280

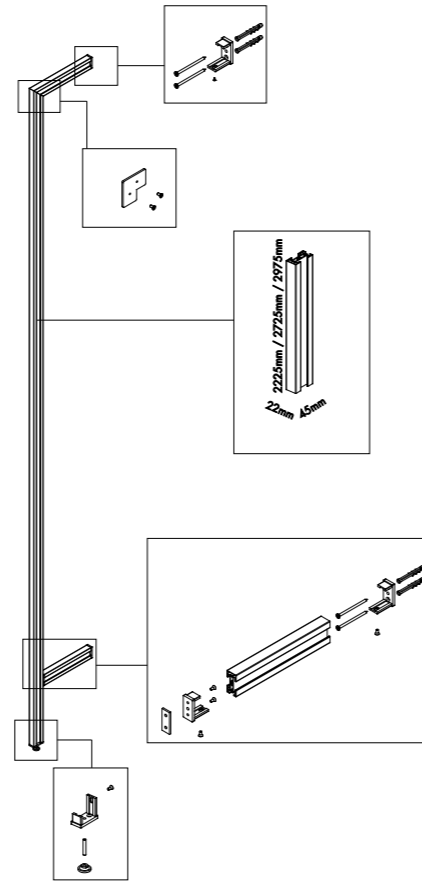

GP3 L-SÄULE | GP3 L-FRAME

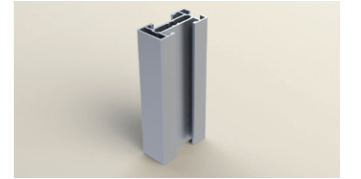
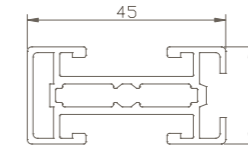

STANDARD OBERFLÄCHEN | STANDARD FINISHES



AL1 – NATUR MATT ELOXIERT
AL1 – NATURAL MATT ANODISED

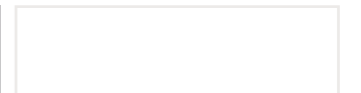

W RAL 9003 WEISS LACKIERT
W RAL 9003 WHITE LAQUERED



A – ANTHRAZIT MATT ELOXIERT
A – ANTHRACITE MATT ANODISED

OBERFLÄCHE COLOR	ART.NR.	MM BxTxH MM WxDxH
AL1	V3L2250X280 AL1	22x280x2250
	V3L2750X280 AL1	22x280x2750
	V3L3000X280 AL1	22x280x3000
W RAL 9003	V3L2250X280 W	22x280x2250
	V3L2750X280 W	22x280x2750
	V3L3000X285 W	22x280x3000
A	V3L2250X280 A	22x280x2250
	V3L2750X280 A	22x280x2750
	V3L3000X280 A	22x280x3000

i AUCH IN INDIVIDUELLEN GRÖSSEN VERFÜGBAR, STANDARD SÄULENTIEFE IST FÜR 500 MM MÖBELTIEFE OPTIMAL | ALSO AVAILABLE IN INDIVIDUAL SIZES, BUT STANDARD DEPTH OF THE SECTION IS OPTIMIZED FOR 500 MM FURNITURE DEPTH

BESTELLUNG VON INDIVIDUELLER HÖHE | ORDERING OF UNIQUE HEIGHT

- BESTELLUNG MIT INDIVIDUELLER HÖHE MÖGLICH | ALSO WITH UNIQUE HEIGHT AVAILABLE
- WÄHLEN SIE DIE ARTIKEL NR. FÜR GRÖßERE HÖHE | CHOOSE THE ITEM CODE FOR HIGHER FRAME
- FÜGEN SIE „-T:[HÖHE IN MM]“ BEI | ADD „-T:[INDIVIDUAL HEIGHT IN MM]“
- ZB. V2F3000X285 AL1 - T:2950 | E.G. V2F300X285 AL1 - T:2950
- PREIS IST GLEICH ZUM PREIS DES GRÖßEREN ELEMENTS | PRICE EQUALS TO THE PRICE OF THE HIGHER ITEM

V3L2250X280
H (mm) 2250
L (mm) 22
P (mm) 280

V3L2750X280
H (mm) 2750
L (mm) 22
P (mm) 280

V3L3000X280
H (mm) 3000
L (mm) 22
P (mm) 280

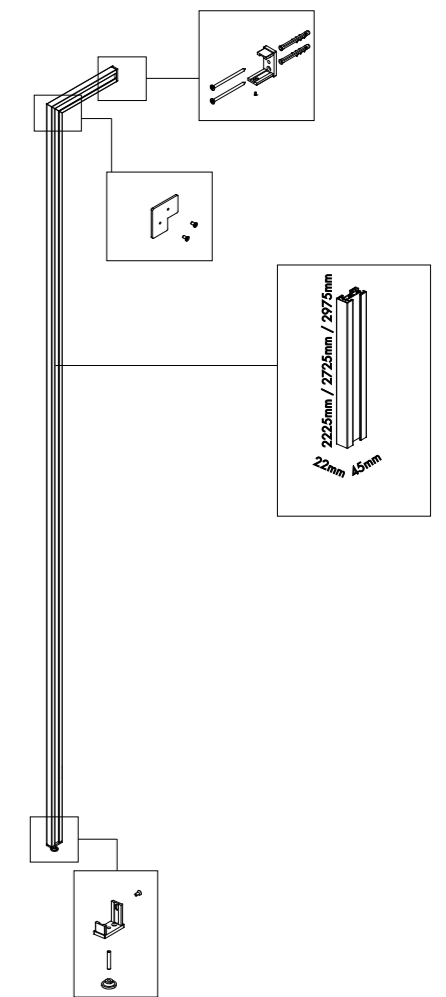

GP2 I-SÄULE MIT VERSTEIFUNG | GP2 I-FRAME WITH REINFORCEMENT

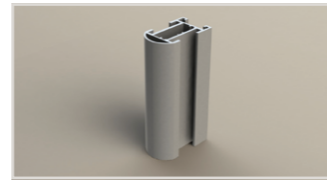
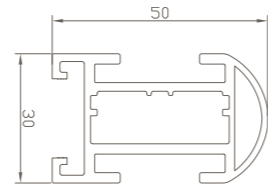
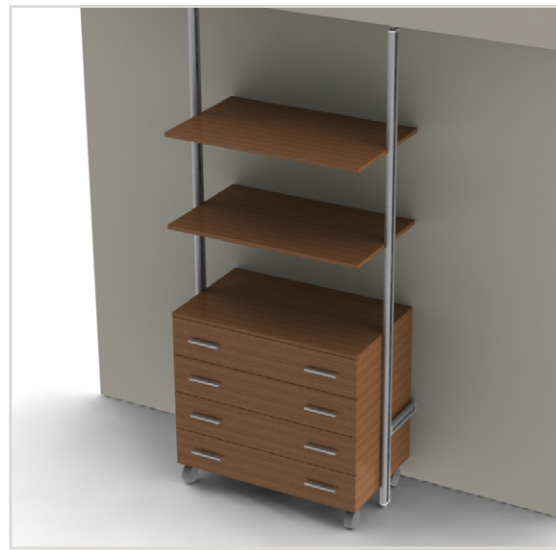

STANDARD OBERFLÄCHEN | STANDARD FINISHES



AL1 – NATUR MATT ELOXIERT
AL1 – NATURAL MATT ANODISED

OBERFLÄCHE COLOR	ART.NR.	MM BxTxH MM WxDxH
AL1	V213050x285 AL1	30x285x3050

i AUCH IN INDIVIDUELLEN GRÖSSEN VERFÜGBAR,
STANDARD SÄULENTIEFE IST FÜR 500 MM MÖBELTIEFE
OPTIMAL | ALSO AVAILABLE IN INDIVIDUAL SIZES, BUT
STANDARD DEPTH OF THE SECTION IS OPTIMIZED FOR
500 MM FURNITURE DEPTH

**BESTELLUNG VON INDIVIDUELLER HÖHE |
ORDERING OF UNIQUE HEIGHT**

- BESTELLUNG MIT INDIVIDUELLER HÖHE MÖGLICH |
ALSO WITH UNIQUE HEIGHT AVAILABLE
- WÄHLEN SIE DIE ARTIKEL NR. FÜR GRÖßERE HÖHE |
CHOOSE THE ITEM CODE FOR HIGHER FRAME
- FÜGEN SIE „-T:[HÖHE IN MM]“ BEI | ADD
„-T:[INDIVIDUAL HEIGHT IN MM]“
- ZB. V2F3000X285 AL1 - T:2950 | E.G. V2F300X285
AL1 - T:2950
- PREIS IST GLEICH ZUM PREIS DES GRÖßEREN
ELEMENTS | PRICE EQUALS TO THE PRICE OF THE
HIGHER ITEM

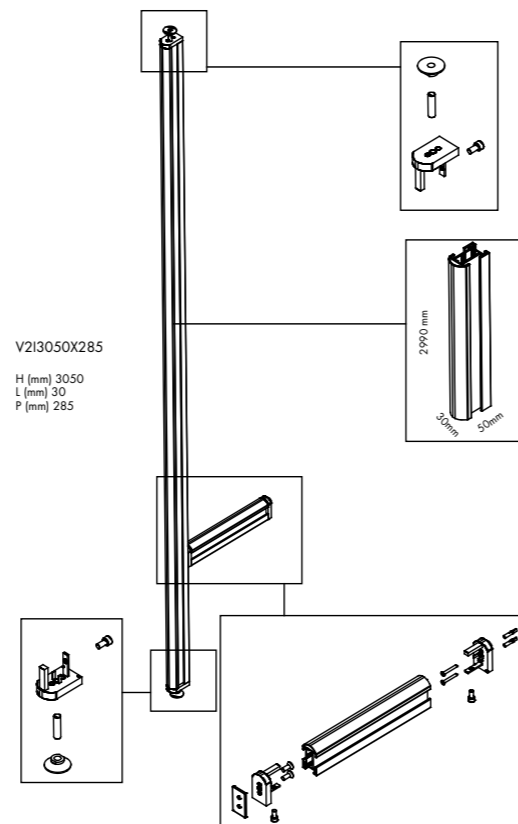

GP2 I-SÄULE OHNE VERSTEIFUNG | GP2 I-FRAME WITHOUT REINFORCEMENT

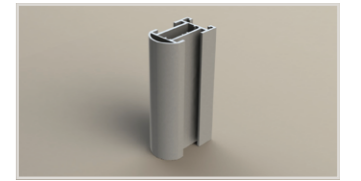
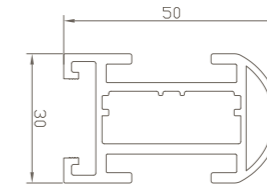

STANDARD OBERFLÄCHEN | STANDARD FINISHES



AL1 – NATUR MATT ELOXIERT
AL1 – NATURAL MATT ANODISED

OBERFLÄCHE COLOR	ART.NR.	MM BxTxH MM WxDxH
AL1	V213050 AL1	30x50x3050

i AUCH IN INDIVIDUELLEN GRÖSSEN VERFÜGBAR,
STANDARD SÄULENTIEFE IST FÜR 500 MM MÖBELTIEFE
OPTIMAL | ALSO AVAILABLE IN INDIVIDUAL SIZES, BUT
STANDARD DEPTH OF THE SECTION IS OPTIMIZED FOR
500 MM FURNITURE DEPTH

**BESTELLUNG VON INDIVIDUELLER HÖHE |
ORDERING OF UNIQUE HEIGHT**

- BESTELLUNG MIT INDIVIDUELLER HÖHE MÖGLICH |
ALSO WITH UNIQUE HEIGHT AVAILABLE
- WÄHLEN SIE DIE ARTIKEL NR. FÜR GRÖßERE HÖHE |
CHOOSE THE ITEM CODE FOR HIGHER FRAME
- FÜGEN SIE „-T:[HÖHE IN MM]“ BEI | ADD
„-T:[INDIVIDUAL HEIGHT IN MM]“
- ZB. V2F3000X285 AL1 - T:2950 | E.G. V2F300X285
AL1 - T:2950
- PREIS IST GLEICH ZUM PREIS DES GRÖßEREN
ELEMENTS | PRICE EQUALS TO THE PRICE OF THE
HIGHER ITEM

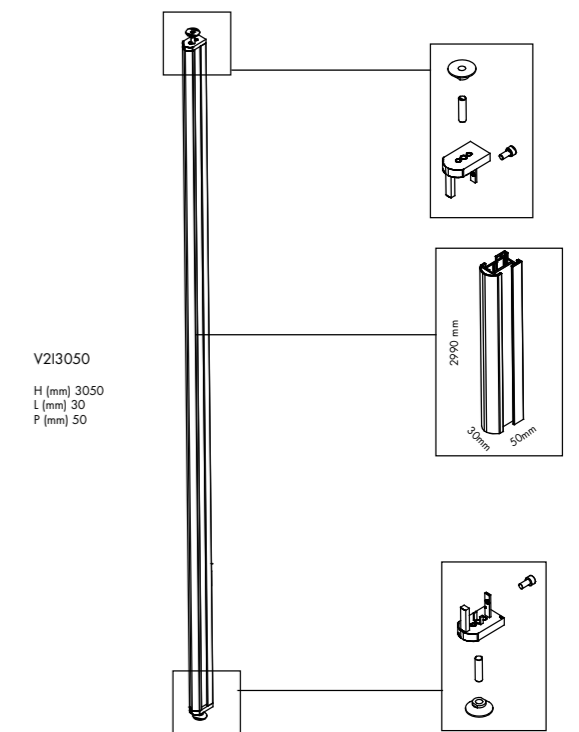

GP3 I-SÄULE MIT VERSTEIFUNG | GP3 I-FRAME WITH REINFORCEMENT

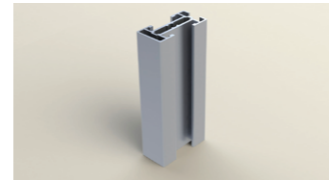
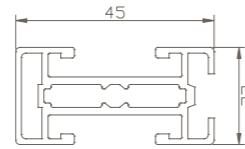
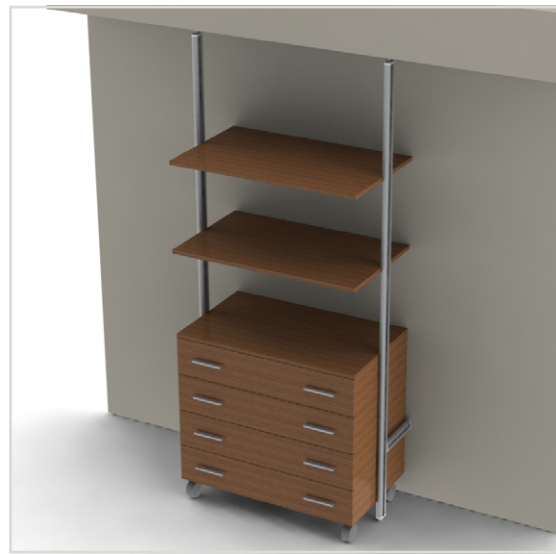

STANDARD OBERFLÄCHEN | STANDARD FINISHES



AL1 – NATUR MATT ELOXIERT
AL1 – NATURAL MATT ANODISED



W RAL 9003 – WEISS LACKIERT
W RAL 9003 – WHITE LAQUERED



A – ANTHRAZIT MATT ELOXIERT
A – ANTHRAZITE MATT ANODISED

OBERFLÄCHE COLOR	ART.NR.	MM BxTxH MM WxDxH
AL1	V313050X280 AL1	22x280x3050
W RAL 9003	V313050X280 W	22x280x3050
A	V313050X280 A	22x280x3050

i AUCH IN INDIVIDUELLEN GRÖSSEN VERFÜGBAR, STANDARD SÄULENTIEFE IST FÜR 500 MM MÖBELTIEFE OPTIMAL | ALSO AVAILABLE IN INDIVIDUAL SIZES, BUT STANDARD DEPTH OF THE SECTION IS OPTIMIZED FOR 500 MM FURNITURE DEPTH

V313050X280
H (mm) 3050
L (mm) 22
P (mm) 280

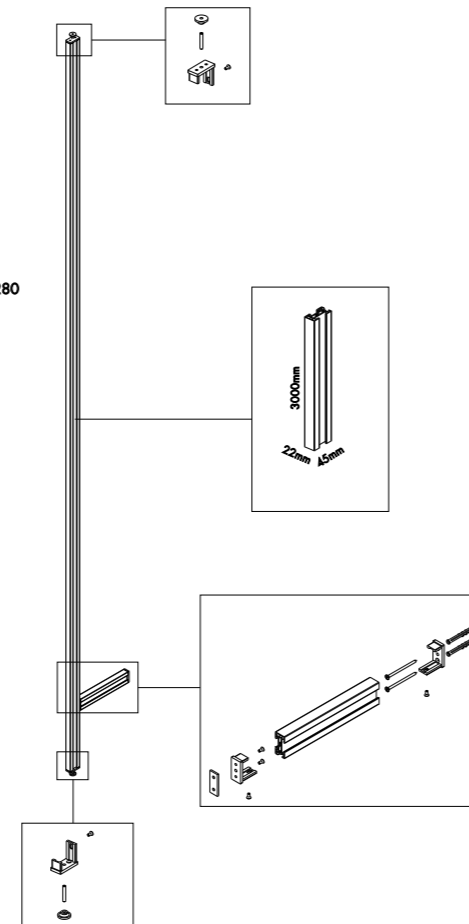

BESTELLUNG VON INDIVIDUELLER HÖHE | ORDERING OF UNIQUE HEIGHT

- BESTELLUNG MIT INDIVIDUELLER HÖHE MÖGLICH | ALSO WITH UNIQUE HEIGHT AVAILABLE
- WÄHLEN SIE DIE ARTIKEL NR. FÜR GRÖßERE HÖHE | CHOOSE THE ITEM CODE FOR HIGHER FRAME
- FÜGEN SIE „-T:[HÖHE IN MM]“ BEI | ADD „-T:[INDIVIDUAL HEIGHT IN MM]“
- ZB. V2F3000X285 AL1 - T:2950 | E.G. V2F300X285 AL1 - T:2950
- PREIS IST GLEICH ZUM PREIS DES GRÖßEREN ELEMENTS | PRICE EQUALS TO THE PRICE OF THE HIGHER ITEM

GP3 I-SÄULE MIT VERSTEIFUNG | GP3 I-FRAME WITHOUT REINFORCEMENT

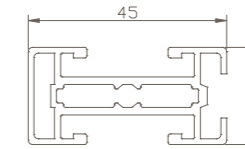

STANDARD OBERFLÄCHEN | STANDARD FINISHES



AL1 – NATUR MATT ELOXIERT
AL1 – NATURAL MATT ANODISED



W RAL 9003 – WEISS LACKIERT
W RAL 9003 – WHITE LAQUERED



A – ANTHRAZIT MATT ELOXIERT
A – ANTHRAZITE MATT ANODISED

OBERFLÄCHE COLOR	ART.NR.	MM BxTxH MM WxDxH
AL1	V313050 AL1	22x45x3050
W RAL 9003	V313050 W	22x45x3050
A	V313050 A	22x45x3050

i AUCH IN INDIVIDUELLEN GRÖSSEN VERFÜGBAR, STANDARD SÄULENTIEFE IST FÜR 500 MM MÖBELTIEFE OPTIMAL | ALSO AVAILABLE IN INDIVIDUAL SIZES, BUT STANDARD DEPTH OF THE SECTION IS OPTIMIZED FOR 500 MM FURNITURE DEPTH

V313050
H (mm) 3050
L (mm) 22
P (mm) 50

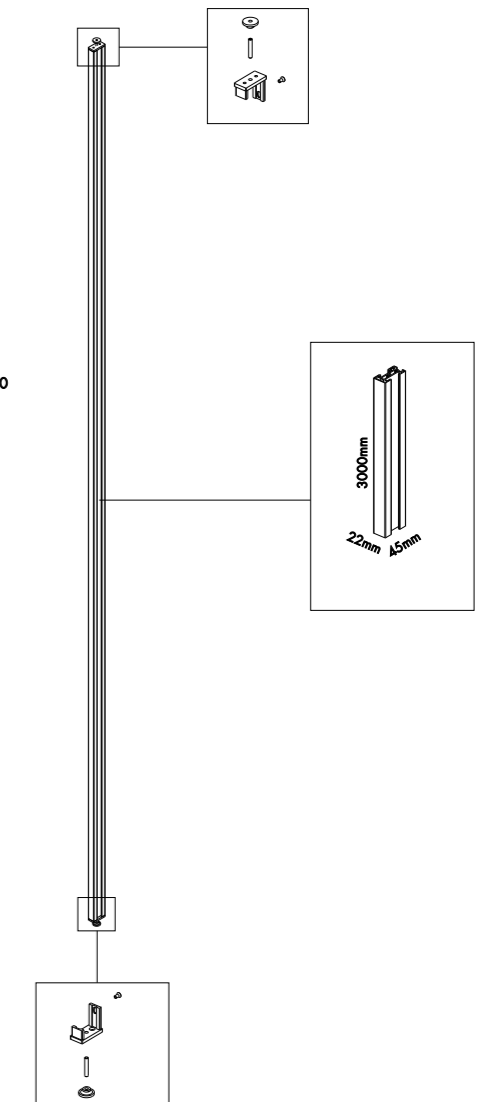

BESTELLUNG VON INDIVIDUELLER HÖHE | ORDERING OF UNIQUE HEIGHT

- BESTELLUNG MIT INDIVIDUELLER HÖHE MÖGLICH | ALSO WITH UNIQUE HEIGHT AVAILABLE
- WÄHLEN SIE DIE ARTIKEL NR. FÜR GRÖßERE HÖHE | CHOOSE THE ITEM CODE FOR HIGHER FRAME
- FÜGEN SIE „-T:[HÖHE IN MM]“ BEI | ADD „-T:[INDIVIDUAL HEIGHT IN MM]“
- ZB. V2F3000X285 AL1 - T:2950 | E.G. V2F300X285 AL1 - T:2950
- PREIS IST GLEICH ZUM PREIS DES GRÖßEREN ELEMENTS | PRICE EQUALS TO THE PRICE OF THE HIGHER ITEM



GP2 C-SÄULE MONTAGE AN DIE WAND | GP2 C-FRAME WALL ATTACHMENT

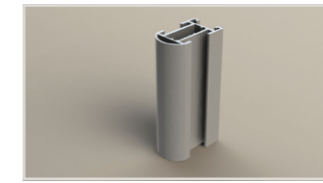
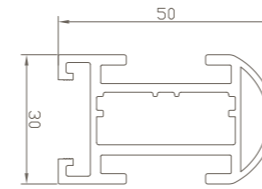

OBERFLÄCHE COLOR	ART.NR.	MM BxTxH MM WxDxH
AL1	V2C1500x285 AL1	30x285x1500
	V2C2000x285 AL1	30x285x2000

V2C2000x285
H (mm) 2000
L (mm) 30
P (mm) 285

V2C1500x285
H (mm) 1500
L (mm) 30
P (mm) 285

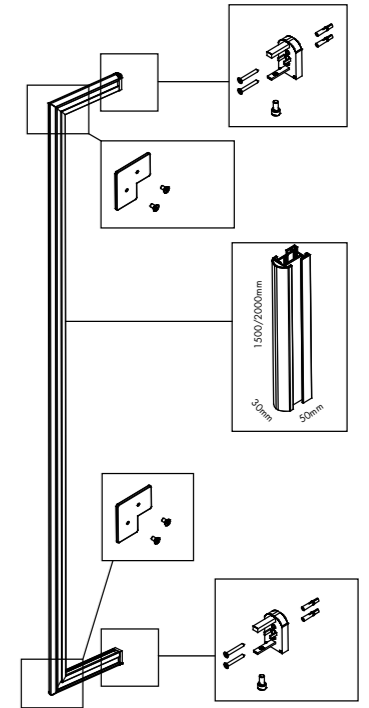

GP3 C-SÄULE MONTAGE AN DIE WAND | GP3 C-FRAME WALL ATTACHMENT

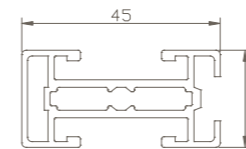

OBERFLÄCHE COLOR	ART.NR.	MM BxTxH MM WxDxH
AL1	V3C1500x280 AL1	22x280x1500
	V3C2000x280 AL1	22x280x2000
W RAL 9003	V3C1500x280 W	22x280x1500
	V3C2000x280 W	22x280x2000
A	V3C1500x280 A	22x280x1500
	V3C2000x280 A	22x280x2000

V3C1500x280
H (mm) 1500
L (mm) 22
P (mm) 280

V3C2000x280
H (mm) 2000
L (mm) 22
P (mm) 280

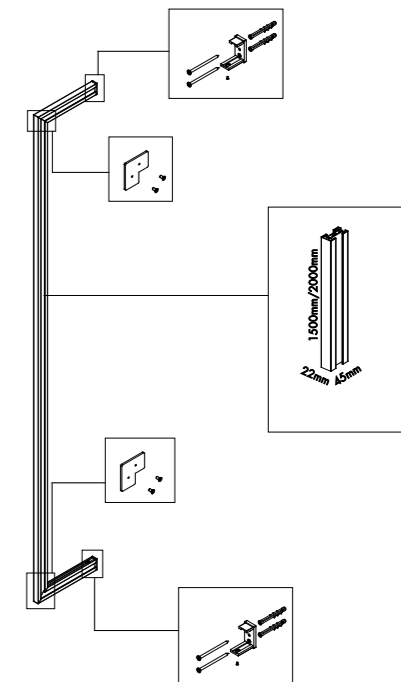

i AUCH IN INDIVIDUELLEN GRÖSSEN VERFÜGBAR, STANDARD SÄULENTIEFE IST FÜR 500 MM MÖBELTIEFE OPTIMAL | ALSO AVAILABLE IN INDIVIDUAL SIZES, BUT STANDARD DEPTH OF THE SECTION IS OPTIMIZED FOR 500 MM FURNITURE DEPTH

BESTELLUNG VON INDIVIDUELLER HÖHE | ORDERING OF UNIQUE HEIGHT

- BESTELLUNG MIT INDIVIDUELLER HÖHE MÖGLICH | ALSO WITH UNIQUE HEIGHT AVAILABLE
- WÄHLEN SIE DIE ARTIKEL NR. FÜR GRÖßERE HÖHE | CHOOSE THE ITEM CODE FOR HIGHER FRAME
- FÜGEN SIE „-T:[HÖHE IN MM]“ BEI | ADD „-T:[INDIVIDUAL HEIGHT IN MM]“
- ZB: V2F300X285 AL1 - T:2950 | E.G. V2F300X285 AL1 - T:2950
- PREIS IST GLEICH ZUM PREIS DES GRÖßEREN ELEMENTS | PRICE EQUALS TO THE PRICE OF THE HIGHER ITEM

GP2 I-SÄULE ECKLÖSUNG | GP2 I-FRAME CORNER SOLUTION

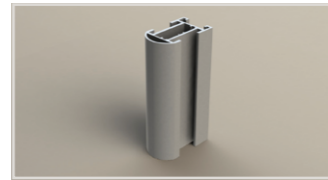
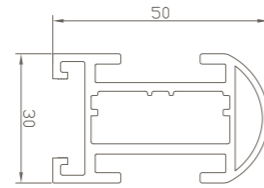
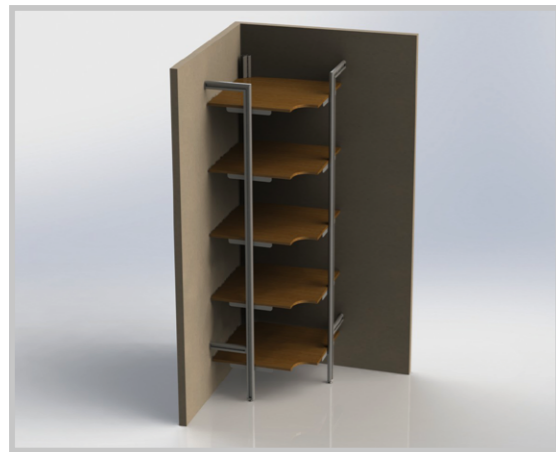

V2SI2250
H (mm) 2250
L (mm) 30
P (mm) 50

V2SI2750
H (mm) 2750
L (mm) 30
P (mm) 50

V2SI3050
H (mm) 3050
L (mm) 30
P (mm) 50

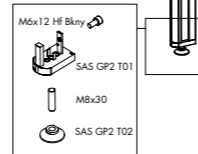

I-SÄULE ECKLÖSUNG | I-FRAME CORNER SOLUTION

OBERFLÄCHE COLOR	ART.NR.	MM BxTxH MM WxDxH
AL1	V2SI2250 AL1	30x50x2250
	V2SI2750 AL1	30x50x2750
	V2SI3050 AL1	30x50x3050

GP3 I-SÄULE ECKLÖSUNG | GP3 I-FRAME CORNER SOLUTION

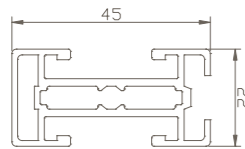

V3SI2250
H (mm) 2250
L (mm) 22

V3SI2750
H (mm) 2750
L (mm) 22

V3SI3050
H (mm) 3050
L (mm) 22

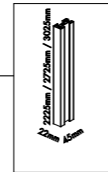
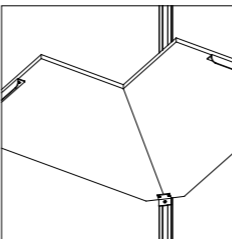

OBERFLÄCHE COLOR	ART.NR.	MM BxTxH MM WxDxH
AL1	V3SI2250 AL1	22x45x2250
	V3SI2750 AL1	22x45x2750
	V3SI3050 AL1	22x45x3050
W RAL 9003	V3SI2250 W	22x45x2250
	V3SI2750 W	22x45x2750
	V3SI3050 W	22x45x3050
A	V3SI2250 A	22x45x2250
	V3SI2750 A	22x45x2750
	V3SI3050 A	22x45x3050

BESTELLUNG VON INDIVIDUELLER HÖHE | ORDERING OF UNIQUE HEIGHT

- BESTELLUNG MIT INDIVIDUELLER HÖHE MÖGLICH | ALSO WITH UNIQUE HEIGHT AVAILABLE
- WÄHLEN SIE DIE ARTIKEL NR. FÜR GRÖßERE HÖHE | CHOOSE THE ITEM CODE FOR HIGHER FRAME
- FÜGEN SIE „-T:[HÖHE IN MM]“ BEI | ADD „-T:[INDIVIDUAL HEIGHT IN MM]“
- ZB. V2F300X285 AL1 - T:2950 | E.G. V2F300X285 AL1 - T:2950
- PREIS IST GLEICH ZUM PREIS DES GRÖßEREN ELEMENTS | PRICE EQUALS TO THE PRICE OF THE HIGHER ITEM

i AUCH IN INDIVIDUELLEN GRÖßEN VERFÜGBAR, STANDARD SÄULENTIEFE IST FÜR 500 MM MÖBELTIEFE OPTIMAL | ALSO AVAILABLE IN INDIVIDUAL SIZES, BUT STANDARD DEPTH OF THE SECTION IS OPTIMIZED FOR 500 MM FURNITURE DEPTH

HOLZBODENTRÄGER LSY | WOOD SHELF HOLDER LSY

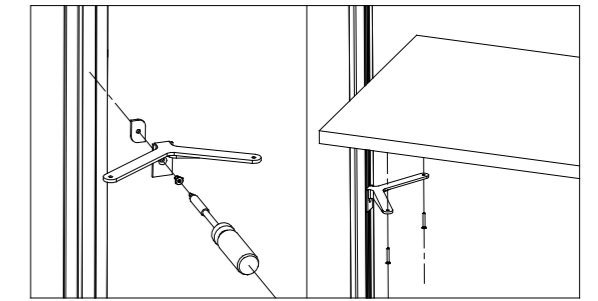
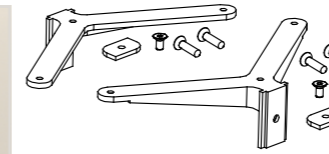

OBERFLÄCHE COLOR	ART.NR.	MM BxTxH MM WxDxH
AL1	LSY AL1	82x203x40
W RAL 9003	LSY W	82x203x40
A	LSY A	82x203x40

- BELASTBARKEIT **MAX. 20 KG** | LOADABILITY **MAX. 20 KG**
- SCHNELLE UND EINFACHE MONTAGE | QUICK AND EASY INSTALLATION
- VERSTELLBAR IN DER HÖHE | HEIGHT ADJUSTABILITY
- NACHTRÄGLICH EINBAUBAR | CAN BE LATER INSTALLED
- REGAL VON UNTEN MIT SCHRAUBEN BEFESTIGT | SHELF IS FROM BOTTOM SCREWED IN

HOLZBODENTRÄGER FÜR ECKLÖSUNG – LSYS | WOOD SHELF HOLDER FOR CORNER SOLUTION – LSYS

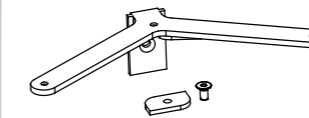

OBERFLÄCHE COLOR	ART.NR.	MM BxTxH MM WxDxH
AL1	LSYS AL1	82x203x40
W RAL 9003	LSYS W	82x203x40
A	LSYS A	82x203x40

- BELASTBARKEIT **MAX. 20 KG** | LOADABILITY **MAX. 20 KG**
- HOLZBODENTRÄGER LSLs SOLL ZUSAMMEN MIT LSY ZU BESTELLT WERDEN | SHELF HOLDER LSLs HAS TO BE ORDERED TOGETHER WITH LSY

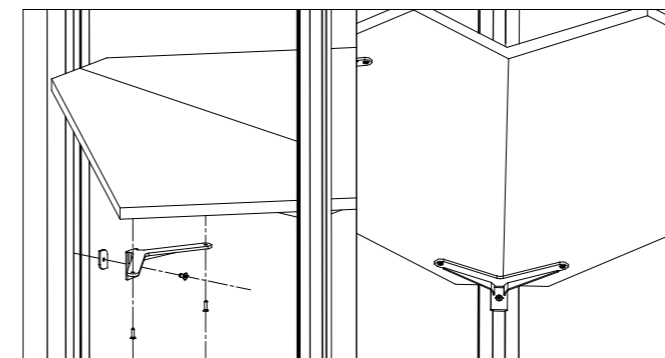

HOLZBODENTRÄGER **LS2L/LS3L** | WOOD SHELF HOLDER **LS2L/LS3L**

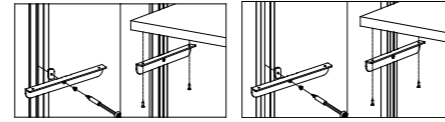
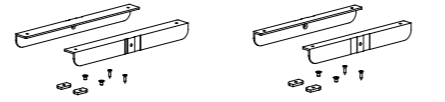
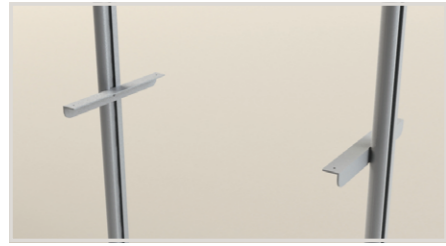

LS2L

LS3L

	OBERFLÄCHE COLOR	ART.NR.	MM BxTxH MM WxDxH
GP2	AL1	LS2L AL1	30x300x30
	AL1	LS3L AL1	20x250x30
GP3	W RAL 9003	LS3L W	20x250x30
	A	LS3L A	20x250x30

— BELASTBARKEIT **MAX. 20 KG** |
LOADABILITY **MAX. 20 KG**

HOLZBODENTRÄGER FÜR ECKLÖSUNG **LSLS** | WOOD SHELF HOLDER FOR CORNER SOLUTION **LSLS**



— BELASTBARKEIT **MAX. 20 KG** | LOADABILITY
MAX. 20 KG

— HOLZBODENTRÄGER LSLS SOLL ZUSAMMEN MIT
LS2L OR LS3L ZU ZU BESTELT WERDEN | SHELF
HOLDER LSLS HAS TO BE ORDERED TOGETHER WITH
LS2L / LS3L

	OBERFLÄCHE COLOR	ART.NR.	MM BxTxH MM WxDxH
	AL1	LSLS AL1	18x45x30
	W RAL 9003	LSLS W	18x45x30
	A	LSLS A	18x45x30

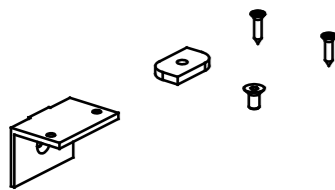

LSLS

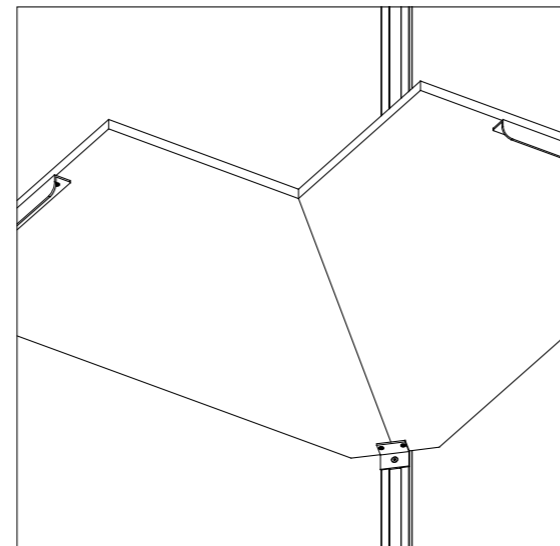

GLASBODENTRÄGER **LSYG** | GLASS SHELF HOLDER **LSYG**

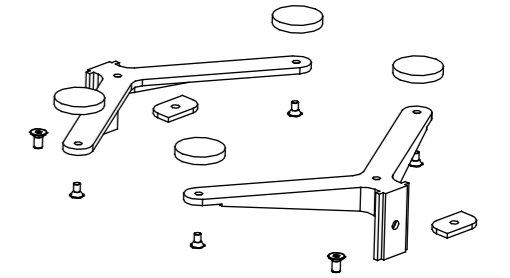

	OBERFLÄCHE COLOR	ART.NR.	MM BxTxH MM WxDxH
	AL1	LSYG AL1	82x203x43
	W RAL 9003	LSYG W	82x203x43
	A	LSYG A	82x203x43

— BELASTBARKEIT **MAX. 20 KG** |
LOADABILITY **MAX. 20 KG**

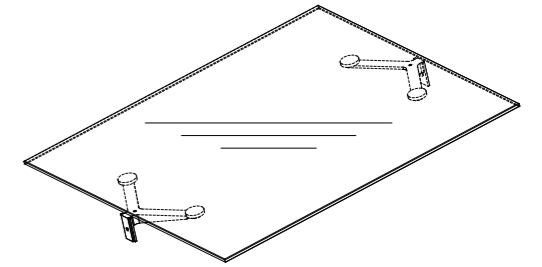

HOLZBODEN | WOODEN SHELF

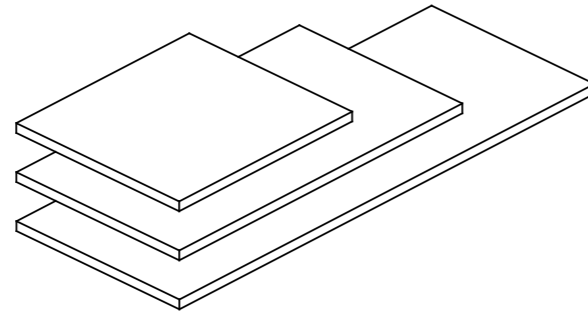
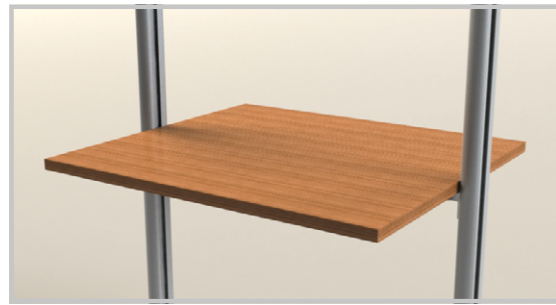

	OBERFLÄCHE COLOR	ART.NR.	MM BxTxH MM WxDxH
500 MM TIEFE 500 MM DEPTH	WEISS WHITE	HSSR-5550-CO	550x500x25
		HSSR-5553-CO	900x500x25
		HSSR-5551-CO	1320x500x25
	MORIER MORIER	HSSR-5550-MO	550x500x25
		HSSR-5553-MO	900x500x25
		HSSR-5551-MO	1320x500x25
	MILANO NUSS MILANO NUT	HSSR-5550-NM	550x500x25
		HSSR-5553-NM	900x500x25
		HSSR-5551-NM	1320x500x25
	BIRKE BIRCH	HSSR-5550-BL	550x500x25
		HSSR-5553-BL	900x500x25
		HSSR-5551-BL	1320x500x25
320 MM TIEFE 320 MM DEPTH	WEISS WHITE	HSSR-5555-CO	550x320x25
		HSSR-5556-CO	900x320x25
	MORIER MORIER	HSSR-5555-MO	550x320x25
		HSSR-5556-MO	900x320x25
	MILANO NUSS MILANO NUT	HSSR-5555-NM	550x320x25
		HSSR-5556-NM	900x320x25
BIRKE BIRCH	HSSR-5555-BL	550x320x25	
	HSSR-5556-BL	900x320x25	

- BELASTBARKEIT MAX. 20 KG | LOADABILITY MAX. 20 KG
- REGAL NACH MASS - BITTE SEHEN SIE SEITE 102 | SHELVES MADE-TO-MEASURE: PLEASE CHECK PAGE 102

! BITTE PRÜFEN SIE DIE MONTAGEANLEITUNG FÜR DIE KORREKTE MONTAGE | PLEASE CHECK THE ASSEMBLY INSTRUCTIONS BEFORE FIXING THE SHELVES

HOLZBODEN FÜR ECKLÖSUNG | WOODEN SHELF FOR CORNER SOLUTION

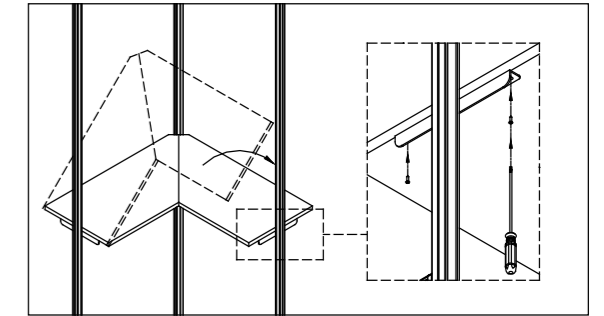

OBERFLÄCHE COLOR	ART.NR.	MM BxTxH MM WxDxH
WEISS WHITE	HSSR-5558-CO	1050x500x25
MORIER MORIER	HSSR-5558-MO	1050x500x25
MILANO NUSS MILANO NUT	HSSR-5558-NM	1050x500x25
BIRKE BIRCH	HSSR-5558-BL	1050x500x25

- DEKOR SPANPLATTE 25 MM, ABS KANTEN 1 MM | DECOR CHIPBOARD 25 MM, ABS EDGE 1 MM
- BELASTBARKEIT MAX. 20 KG | LOADABILITY MAX. 20 KG
- TIEFE 500 MM | DEPTH 500 MM
- VERFÜGBAR FÜR LSYS; LSL5 | AVAILABLE FOR LSYS; LSL5



HOLZBODEN MIT ALU-REGALSEITE (LSW) | WOODEN SHELF WITH ALUMINIUM SHELF-SIDE (LSW)



OBERFLÄCHE COLOR	ART.NR.	MM BxTxH MM WxDxH
WEISS WHITE	HSSR-W5550-CO	544x500x18
	HSSR-W5553-CO	894x500x18
	HSSR-W5551-CO	1314x500x18
MORIER MORIER	HSSR-W5550-MO	544x500x18
	HSSR-W5553-MO	894x500x18
	HSSR-W5551-MO	1314x500x18
MILANO NUSS MILANO NUT	HSSR-W5550-NM	544x500x18
	HSSR-W5553-NM	894x500x18
	HSSR-W5551-NM	1314x500x18
BIRKE BIRCH	HSSR-W5550-BL	544x500x18
	HSSR-W5553-BL	894x500x18
	HSSR-W5551-BL	1314x500x18

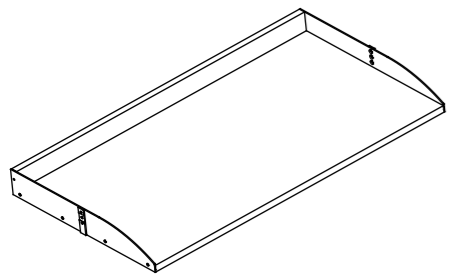

- DEKOR SPANPLATTE 18 MM, ABS KANTEN 1 MM | DECOR CHIPBOARD 18 MM, ABS EDGE 1 MM
- BELASTBARKEIT MAX. 30 KG | LOADABILITY MAX. 30 KG
- TIEFE 500 MM | DEPTH 500 MM
- SET BEEINHÄLTET DIE REGALSEITEN | SET CONTAINS THE SHELF-SIDES

HOLZBODEN MIT ALU-REGALSEITE (LSWS) FÜR ECKLÖSUNG | WOODEN SHELF WITH ALUMINIUM SHELF-SIDE (LSWS) FOR CORNER SOLUTION



OBERFLÄCHE COLOR	ART.NR.	MM BxTxH MM WxDxH
WEISS WHITE	HSSR-W5558-CO	1050x500x18
MORIER MORIER	HSSR-W5558-MO	1050x500x18
MILANO NUSS MILANO NUT	HSSR-W5558-NM	1050x500x18
BIRKE BIRCH	HSSR-W5558-BL	1050x500x18

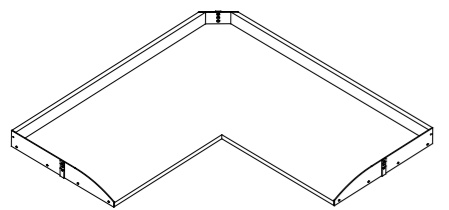

- DEKOR SPANPLATTE 18 MM, ABS KANTEN 1 MM | DECOR CHIPBOARD 18 MM, ABS EDGE 1 MM
- BELASTBARKEIT MAX. 30 KG | LOADABILITY MAX. 30 KG
- TIEFE 500 MM | DEPTH 500 MM
- SET BEEINHÄLTET DIE REGALSEITEN | SET CONTAINS THE SHELF-SIDES

IM WINKEL VERSTELLBARE HOLZBODEN | IN ANGLE ADJUSTABLE SHELF

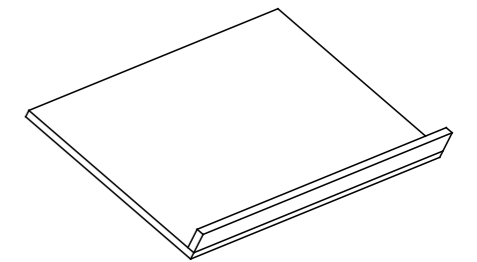

OBERFLÄCHE COLOR	ART.NR.	MM BxTxH MM WxDxH	NEIGUNGSWINKEL
WEISS WHITE	HSSR-HLA-550-CO	550x500x70	10° - 30° - 50°
	HSSR-HLA-900-CO	900x500x70	10° - 30° - 50°
	HSSR-HLA-1320-CO	1320x500x70	10° - 30° - 50°
MORIER MORIER	HSSR-HLA-550-MO	550x500x70	10° - 30° - 50°
	HSSR-HLA-900-MO	900x500x70	10° - 30° - 50°
	HSSR-HLA-1320-MO	1320x500x70	10° - 30° - 50°
MILANO NUSS MILANO NUT	HSSR-HLA-550-NM	550x500x70	10° - 30° - 50°
	HSSR-HLA-900-NM	900x500x70	10° - 30° - 50°
	HSSR-HLA-1320-NM	1320x500x70	10° - 30° - 50°
BIRKE BIRCH	HSSR-HLA-550-BL	550x500x70	10° - 30° - 50°
	HSSR-HLA-900-BL	900x500x70	10° - 30° - 50°
	HSSR-HLA-1320-BL	1320x500x70	10° - 30° - 50°

- DEKOR SPANPLATTE 18 MM, ABS KANTEN 1 MM | DECOR CHIPBOARD 18 MM, ABS EDGE 1 MM
- BELASTBARKEIT MAX. 20 KG | LOADABILITY MAX. 20 KG
- TIEFE 500 MM | DEPTH 500 MM
- VERFÜGBAR FÜR LS2LA, LS3LA | AVAILABLE FOR LS2LA, LS3LA

REGAL NACH MASS | MADE-TO-MEASURE SHELF

- BESTELLUNG MIT INDIVIDUELLER BREITE MÖGLICH | ALSO WITH UNIQUE WIDTH AVAILABLE
- WÄHLEN SIE DIE ARTIKEL NR. FÜR GRÖßERE BREITE | CHOOSE THE ITEM CODE FOR WIDER SHELF
- FÜGEN SIE „-T:[BREITE IN MM]“ BEI | ADD „-T:[INDIVIDUAL WIDTH IN MM]“
- ZB. HSSR-5553-MO - T:850 | E.G. HSSR-5553-MO - T:850
- PREIS: 9,5 € | PRICE: 9.5 €

GLASBODEN | GLASS SHELF

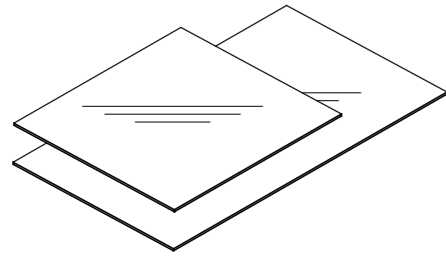
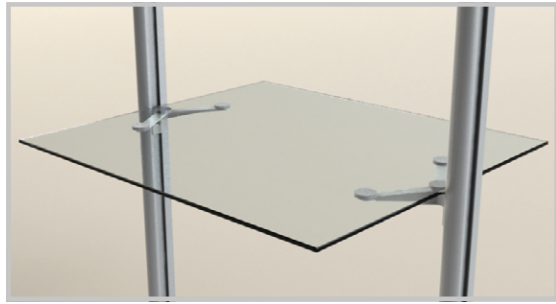

ART.NR.	MM BxTxH MM WxDxH
D3S550	550x500x6
D3S900	900x500x6
ES550	550x500x6
ES900	900x500x6

- 6 MM GEHÄRTETES SICHERHEITSGLAS | 6 MM TEMPERED SAFETY GLASS
- TIEFE 500 MM | DEPTH 500 MM
- VERFÜGBAR FÜR LSYG | AVAILABLE FOR LSYG

KORPUSHALTER LS2KL / LS3KL | BOX HOLDER LS2KL / LS3KL

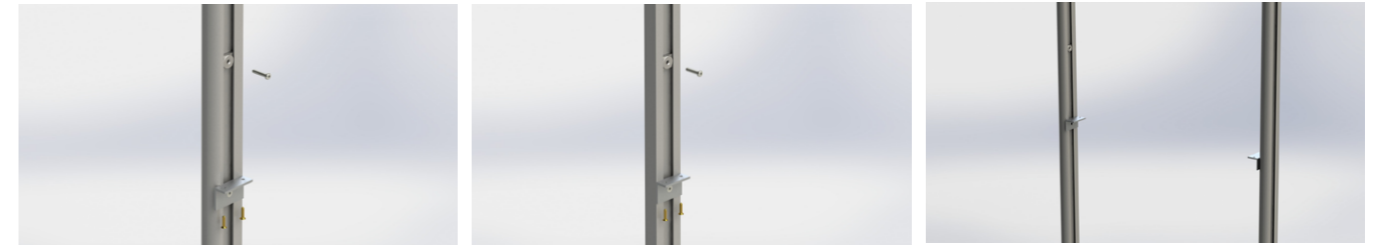

MONTAGE FÜR GP2 | ASSEMBLY FOR GP2 MONTAGE FÜR GP3 | ASSEMBLY FOR GP3

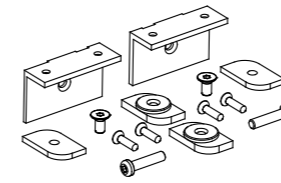

LS2KL

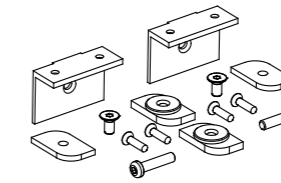

LS3KL

OBERFLÄCHE COLOR	ART.NR.	MM BxTxH MM WxDxH
AL1	LS2KL AL1	18x50x30
AL1	LS3KL AL1	18x45x30
W	LS3KL W	18x45x30
A	LS3KL A	18x45x30

- BELASTBARKEIT MAX. 30 KG | LOADABILITY MAX. 30 KG

ROLLER SSS-5555-2 | ROLLER SSS-5555-2

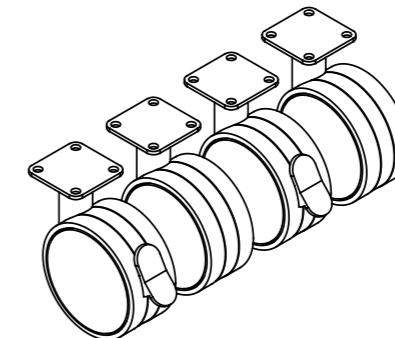

ART.NR.	MM BxTxH MM WxDxH
SSS-5555-2	80x60

*1 SET = 4 STK | 1 SET = 4 PCS

KORPUS MIT 2 SCHUBLADEN | BOX WITH 2 DRAWERS

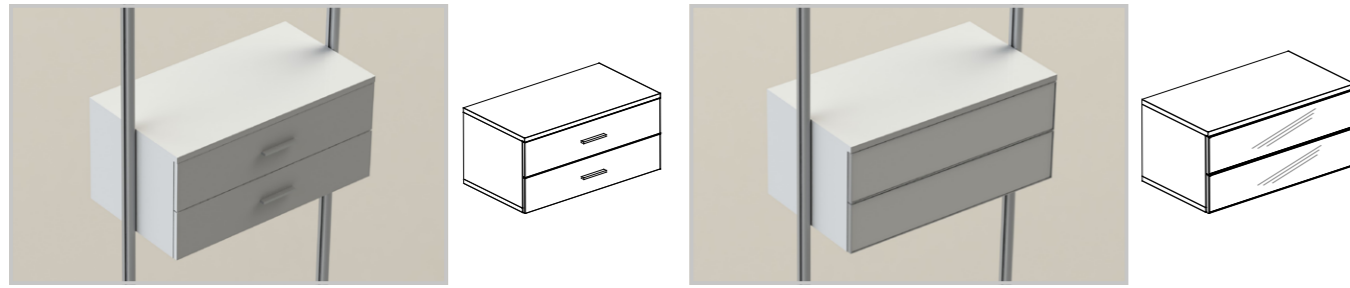

	OBERFLÄCHE COLOR	ART.NR.	MM BxTxH MM WxDxH
MIT HOLZFRONT WITH WOODEN FRONT	WEISS WHITE	HSSR-4442XX-CO	550x500x408
		HSSR-4447XX-CO	900x500x408
	MORIER MORIER	HSSR-4442XX-MO	550x500x408
		HSSR-4447XX-MO	900x500x408
	MILANO NUSS MILANO NUT	HSSR-4442XX-NM	550x500x408
		HSSR-4447XX-NM	900x500x408
MIT GLASFRONT IN ALU-RAHMEN WITH GLASS FRONTS IN ALU FRAMES	BIRKE BIRCH	HSSR-4442XX-BL	550x500x408
		HSSR-4447XX-BL	900x500x408
	WEISS/ LB9 WHITE/ LB9	HSSR-4442PP-CO-LB9	550x500x408
		HSSR-4447PP-CO-LB9	900x500x408
	WEISS/ PW WHITE/ PW	HSSR-4442PP-CO-PW	550x500x408
		HSSR-4447PP-CO-PW	900x500x408
	MORIER/ LB9 MORIER/ LB9	HSSR-4442PP-MO-LB9	550x500x408
		HSSR-4447PP-MO-LB9	900x500x408
	MORIER/ PW MORIER/ PW	HSSR-4442PP-MO-PW	550x500x408
		HSSR-4447PP-MO-PW	900x500x408
	MILANO NUSS / LB9 MILANO NUT / LB9	HSSR-4442PP-NM-LB9	550x500x408
		HSSR-4447PP-NM-LB9	900x500x408
MILANO NUSS / PW MILANO NUT / PW	HSSR-4442PP-NM-PW	550x500x408	
	HSSR-4447PP-NM-PW	900x500x408	
BIRKE / LB9 BIRCH / LB9	HSSR-4442PP-BL-LB9	550x500x408	
	HSSR-4447PP-BL-LB9	900x500x408	
BIRKE / PW BIRCH / PW	HSSR-4442PP-BL-PW	550x500x408	
	HSSR-4447PP-BL-PW	900x500x408	

— DEKOR SPANPLATTE 18 MM, ABS KANTEN 1 MM | DECOR CHIPBOARD 18 MM, ABS EDGE 1 MM

— AUSFÜHRUNG DER SCHUBLADEN | TYPE OF THE DRAWERS:
PP: PUSH-OPEN | **PP:** PUSH-OPEN
SM: MIT GRIFF* | **SM:** WITH HANDLE*

— FÜGEN SIE BITTE PP ODER SM IN DER ARTIKEL NR. EIN. Z.B.:
 HSSR-4442PP-CO ANSTATT HSSR-4442XX-CO | PLEASE ADD PP OR SM IN THE ART. CODE INSTEAD OF XX - SO EG. HSSR-4442PP-CO INSTEAD OF HSSR-4442XX-CO

— TIEFE 500 MM | DEPTH 500 MM

GLASFRONTEN | GLASS FRONTS



GRIFF | HANDLE



NATUR MATT ELOXIERT | NATURAL MATT ANODISED
 *NUR FÜR HOLZFRONT | ONLY FOR WOODEN FRONT

SEPARAT ZU BESTELLEN | TO BE ORDERED SEPARATELY

ART. NR. SAS 6206K 128/148

KORPUS MIT 3 SCHUBLADEN | BOX WITH 3 DRAWERS

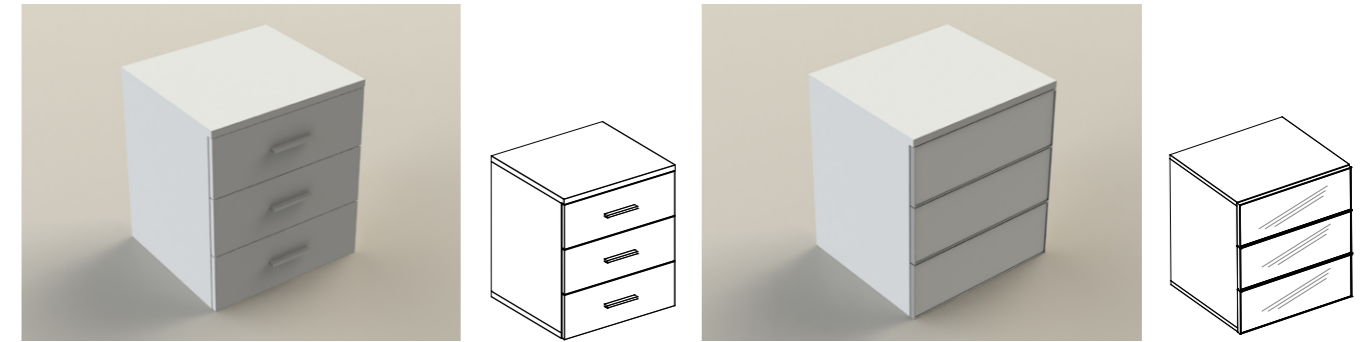

	OBERFLÄCHE COLOR	ART.NR.	MM BxTxH MM WxDxH
MIT HOLZFRONT WITH WOODEN FRONT	WEISS WHITE	HSSR-4417XX-CO	550x500x598
		HSSR-4434XX-CO	900x500x598
	MORIER MORIER	HSSR-4417XX-MO	550x500x598
		HSSR-4434XX-MO	900x500x598
	MILANO NUSS MILANO NUT	HSSR-4417XX-NM	550x500x598
		HSSR-4434XX-NM	900x500x598
MIT GLASFRONT IN ALU-RAHMEN WITH GLASS FRONTS IN ALU FRAMES	BIRKE BIRCH	HSSR-4417XX-BL	550x500x598
		HSSR-4434XX-BL	900x500x598
	WEISS/ LB9 WHITE/ LB9	HSSR-4417PP-CO-LB9	550x500x598
		HSSR-4434PP-CO-LB9	900x500x598
	WEISS/ PW WHITE/ PW	HSSR-4417PP-CO-PW	550x500x598
		HSSR-4434PP-CO-PW	900x500x598
	MORIER/ LB9 MORIER/ LB9	HSSR-4417PP-MO-LB9	550x500x598
		HSSR-4434PP-MO-LB9	900x500x598
	MORIER/ PW MORIER/ PW	HSSR-4417PP-MO-PW	550x500x598
		HSSR-4434PP-MO-PW	900x500x598
	MILANO NUSS / LB9 MILANO NUT / LB9	HSSR-4417PP-NM-LB9	550x500x598
		HSSR-4434PP-NM-LB9	900x500x598
MILANO NUSS / PW MILANO NUT / PW	HSSR-4417PP-NM-PW	550x500x598	
	HSSR-4434PP-NM-PW	900x500x598	
BIRKE / LB9 BIRCH / LB9	HSSR-4417PP-BL-LB9	550x500x598	
	HSSR-4434PP-BL-LB9	900x500x598	
BIRKE / PW BIRCH / PW	HSSR-4417PP-BL-PW	550x500x598	
	HSSR-4434PP-BL-PW	900x500x598	

— DEKOR SPANPLATTE 18 MM, ABS KANTEN 1 MM | DECOR CHIPBOARD 18 MM, ABS EDGE 1 MM

— AUSFÜHRUNG DER SCHUBLADEN | TYPE OF THE DRAWERS:
PP: PUSH-OPEN | **PP:** PUSH-OPEN
SM: MIT GRIFF* | **SM:** WITH HANDLE*

— FÜGEN SIE BITTE PP ODER SM IN DER ARTIKEL NR. EIN. Z.B.:
 HSSR-4442PP-CO ANSTATT HSSR-4442XX-CO | PLEASE ADD PP OR SM IN THE ART. CODE INSTEAD OF XX - SO EG. HSSR-4442PP-CO INSTEAD OF HSSR-4442XX-CO

— TIEFE 500 MM | DEPTH 500 MM

GLASFRONTEN | GLASS FRONTS

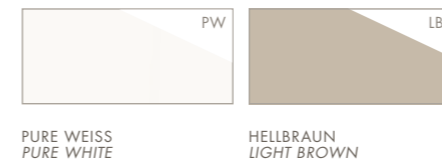

GRIFF | HANDLE



NATUR MATT ELOXIERT | NATURAL MATT ANODISED

*NUR FÜR HOLZFRONT | ONLY FOR WOODEN FRONT

SEPARAT ZU BESTELLEN | TO BE ORDERED SEPARATELY

ART. NR. SAS 6206K 128/148

KORPUS MIT 2 GLASTÜREN IN ALU-RAHMEN | BOX WITH 2 GLASS DOORS IN ALUMINIUM FRAME

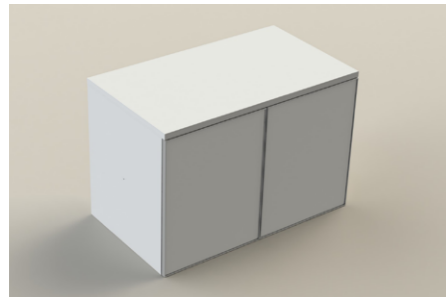

- DEKOR SPANPLATTE 18 MM, ABS KANTEN 1 MM | DECOR CHIPBOARD 18 MM, ABS EDGE 1 MM
- AUSFÜHRUNG DER SCHUBLADEN | TYPE OF THE DRAWERS:
PP: PUSH-OPEN | **PP:** PUSH-OPEN
- TIEFE 500 MM | DEPTH 500 MM

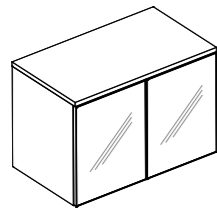

OBERFLÄCHE COLOR	ART.NR.	MM BxTxH MM WxDxH
WEISS/ LB9 WHITE/ LB9	HSSR-4435PP-CO-LB9	900x500x598
WEISS/ PW WHITE/ PW	HSSR-4435PP-CO-PW	900x500x598
MORIER/ LB9 MORIER/ LB9	HSSR-4435PP-MO-LB9	900x500x598
MORIER/ PW MORIER/ PW	HSSR-4435PP-MO-PW	900x500x598
MILANO NUSS /LB9 MILANO NUT/LB9	HSSR-4435PP-NM-LB9	900x500x598
MILANO NUSS/PW MILANO NUT/PW	HSSR-4435PP-NM-PW	900x500x598
BIRKE/ LB9 BIRCH/ LB9	HSSR-4435PP-BL-LB9	900x500x598
BIRKE/ PW BIRCH/ PW	HSSR-4435PP-BL-PW	900x500x598

KLEIDERSTANGE (1 STANGE UND 2 HALTERUNG / SET) | CLOTHES ROD (1 ROD AND 2 FITTINGS / SET)

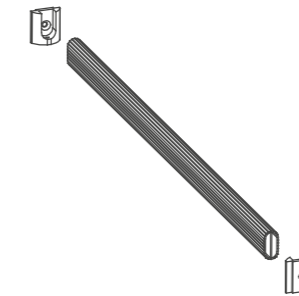
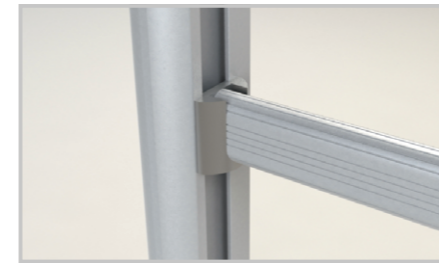

OBERFLÄCHE COLOR	ART.NR.	MM BxTxH MM WxDxH
AL1	LSKS 550 AL1	550x30x36
	LSKS 900 AL1	900x30x36
	LSKS 1320 AL1	1320x30x36
W	LSKS 550 W	550x30x36
	LSKS 900 W	900x30x36
	LSKS 1320 W	1320x30x36
A	LSKS 550 A	550x30x36
	LSKS 900 A	900x30x36
	LSKS 1320 A	1320x30x36

KORPUS MIT FACHEINTEILUNG (AUCH INDIVIDUELLE BREITE IST MÖGLICH) | BOX WITH SECTIONS (ALSO IN UNIQUE WIDTH)

OBERFLÄCHE COLOR	ART.NR.	MM BxTxH MM WxDxH
WEISS WHITE	HSSR-4405-CO	550x480x598
	HSSR-4409-CO	900x480x598
MORIER MORIER	HSSR-4405-MO	550x480x598
	HSSR-4409-MO	900x480x598
MILANO NUSS MILANO NUT	HSSR-4405-NM	550x480x598
	HSSR-4409-NM	900x480x598
BIRKE BIRCH	HSSR-4405-BL	550x480x598
	HSSR-4409-BL	900x480x598

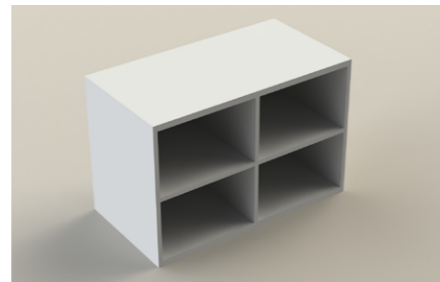

- DEKOR SPANPLATTE 18 MM, ABS KANTEN 1 MM | DECOR CHIPBOARD 18 MM, ABS EDGE 1 MM
- TIEFE 500 MM | DEPTH 500 MM

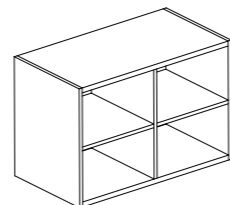

KLEIDERSTANGE FÜR ECKLÖSUNG (2 STANGE UND 4 HALTERUNG / SET) | CLOTHES ROD FOR CORNER SOLUTION (2 RODS AND 4 FITTINGS / SET)

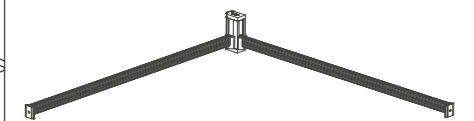
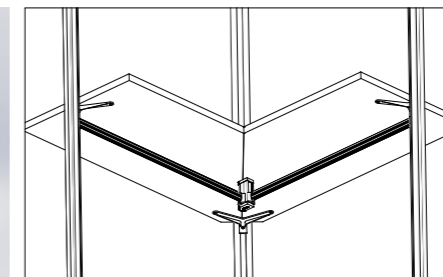

OBERFLÄCHE COLOR	ART.NR.	MM BxTxH MM WxDxH
AL1	LSRS 1050 AL1	750x760x120
W	LSRS 1050 W	750x760x120
A	LSRS 1050 A	750x760x120

KLEIDERSTANGE UND HALTERUNGEN KOMPLETT IN SET FÜR ECKREGALEN | CLOTHES ROD AND FITTINGS IN COMPLETE SET FOR CORNER SHELF

BESTELLUNG MIT INDIVIDUELLER BREITE MÖGLICH | ALSO WITH UNIQUE WIDTH AVAILABLE

- WÄHLEN SIE DIE ARTIKEL NR. FÜR GRÖßER BREITE | CHOOSE THE ITEM CODE FOR WIDER BOX
- FÜGEN SIE „-T:[BREITE IN MM]“ BEI | ADD „-T:[INDIVIDUAL WIDTH IN MM]“
- ZB. | EG.: HSSR-3309-CO-T:850
- PREIS IST GLEICH ZUM PREIS DES GRÖßEREN ELEMENTS | PRICE EQUALS TO THE PRICE OF THE WIDER ITEM.

KLEIDERLIFT (INKL. BEFESTIGUNGSELEMENTE) | LIFT-UP CLOTHES ROD (WITH FIXING ITEMS)

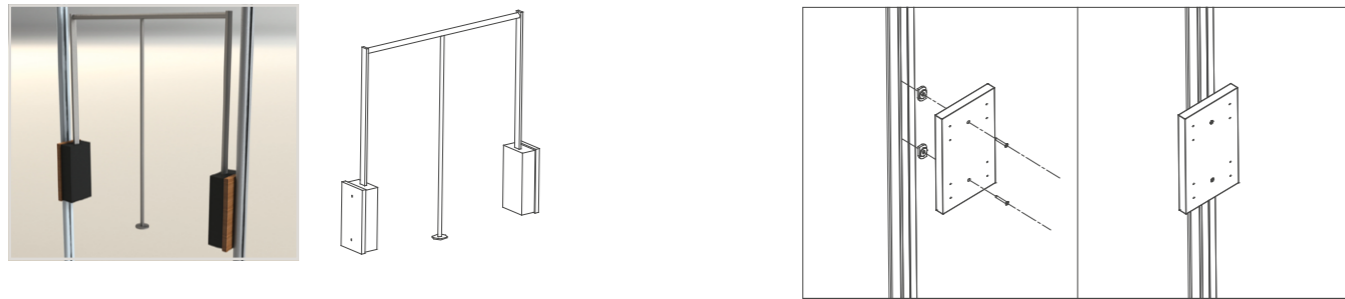

OBERFLÄCHE COLOR	ART.NR.	MM BxTxH MM WxDxH
WEISS WHITE	RH900V-CO	900x160x845
MORIER MORIER	RH900V-MO	900x160x845
MILANO NUSS MILANO NUT	RH900V-NM	900x160x845
BIRKE BIRCH	RH900V-BL	900x160x845

SET BEEINHÄLT ALLE BESCHLÄGE UND KELIDERLIFT. BEFESTIGUNG DURCH SEITENTEIL AUS 18 MM SPANPLATTE, IDENTISCH MIT DER FARBE | SET CONTAINS ALL THE FITTINGS AND LIFT-UP CLOTHES ROD. FIXING THROUGH 18 MM CHIPBOARD THAT COLOUR MATCHES TO THE COLOUR OF THE OTHER WOOD ITEMS.

— RASTERBREITE 900 MM | SECTION WIDTH 900 MM

AUSZIEHBARER HOSENHALTER (MIT HOLZ-SEITE) | PULL-OUT TROUSERS RACK (WITH WOODEN SIDE)



OBERFLÄCHE COLOR	Art.Nr.	MM BxTxH MM WxDxH
WEISS WHITE	KN900A-CO	900x500x85
MORIER MORIER	KN900A-MO	900x500x85
MILANO NUSS MILANO NUT	KN900A-NM	900x500x85
BIRKE BIRCH	KN900A-BL	900x500x85

SET BEINHÄLT DEN HOSENHALTER MIT 18 MM HOLZRAHMEN, DIE AUSZUGSSCHIENE UND DIE AUFNAHMEPLATTE. BEFESTIGUNG FOLGT DURCH DIE SET LS2KL ODER LS3KL, WELCHES SEPARAT ZU BESTELLEN IST. | SET CONTAINS TROUSERS RACK FRAMED WITH 18 MM WOOD, THE DRAWER SIDE RUNNER AND THE WOOD SIDES. FIXING THROUGH LS2KL OR LS3KL THAT SHALL BE ORDERED SEPARATELY.

— RASTERBREITE 900 MM | SECTION WIDTH 900 MM

AUSZIEHBARER KORB | PULL-OUT BASKET

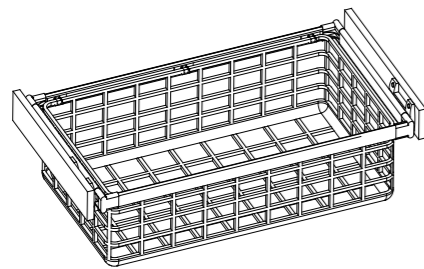

OBERFLÄCHE COLOR	ART.NR.	MM BxTxH MM WxDxH
WEISS WHITE	KK900V-CO	900x500x135
MORIER MORIER	KK900V-MO	900x500x135
MILANO NUSS MILANO NUT	KK900V-NM	900x500x135
BIRKE BIRCH	KK900V-BL	900x500x135



— ACHTUNG! BEFESTIGUNG FOLGT DURCH DIE SET LS2KL ODER LS3KL, WELCHES SEPARAT ZU BESTELLEN IST. | WATCH OUT! FIXING THROUGH LS2KL OR LS3KL THAT SHALL BE ORDERED SEPARATELY.

— RASTERBREITE 900 MM | SECTION WIDTH 900 MM

AUSZIEHBARER HOSENHALTER | PULL-OUT TROUSERS RACK

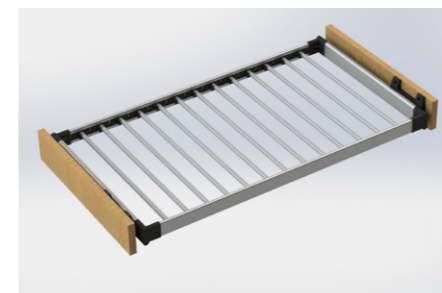

OBERFLÄCHE COLOR	ART.NR.	MM BxTxH MM WxDxH
WEISS WHITE	KN900V-CO	900x500x105
MORIER MORIER	KN900V-MO	900x500x105
MILANO NUSS MILANO NUT	KN900V-NM	900x500x105
BIRKE BIRCH	KN900V-BL	900x500x105

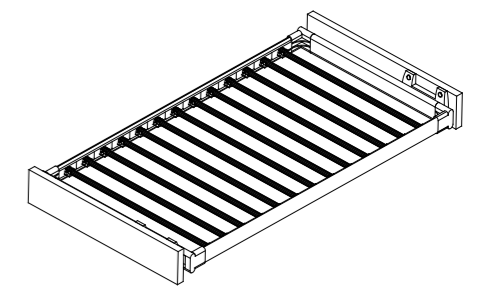

SET BEINHÄLT DEN HOSENHALTER, DIE AUSZUGSSCHIENE UND DIE AUFNAHMEPLATTE (18 MM SPANPLATTE). BEFESTIGUNG FOLGT DURCH DIE SET LS2KL ODER LS3KL, WELCHES SEPARAT ZU BESTELLEN IST. | SET CONTAINS TROUSERS RACK, THE DRAWER SIDE RUNNER AND THE WOOD SIDES (18 MM CHIPBOARD). FIXING THROUGH LS2KL OR LS3KL THAT SHALL BE ORDERED SEPARATELY.

— RASTERBREITE 900 MM | SECTION WIDTH 900 MM

AUSZIEHBARER SCHUHHALTER | PULL-OUT SHOE RACK

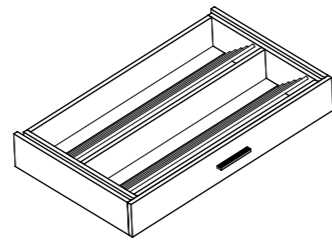

OBERFLÄCHE COLOR	ART.NR.	MM BxTxH MM WxDxH
WEISS WHITE	KC900A-CO	900x500x148
MORIER MORIER	KC900A-MO	900x500x148
MILANO NUSS MILANO NUT	KC900A-NM	900x500x148
BIRKE BIRCH	KC900A-BL	900x500x148

SET BEINHALTET DEN SCHUHHALTER, DIE AUSZUGSSCHIENE UND DIE AUFNAHMEPLATTE (18 MM SPANPLATTE). BEFESTIGUNG FOLGT DURCH DIE SET LS2KL ODER LS3KL, WELCHES SEPARAT ZU BESTELLEN IST. | SET CONTAINS SHOE RACK, THE DRAWER SIDE RUNNER AND THE WOOD SIDES (18 MM CHIPBOARD). FIXING THROUGH LS2KL OR LS3KL THAT SHALL BE ORDERED SEPARATELY.

— RASTERBREITE 900 MM | SECTION WIDTH 900 MM

AUSZIEHBARER KRAWATTENHALTER | PULL-OUT TIE HOLDER

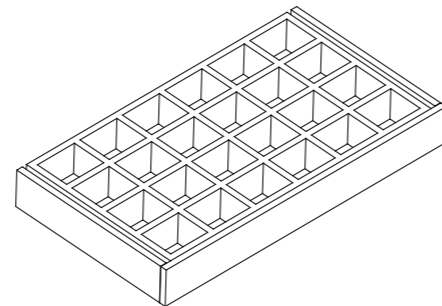

OBERFLÄCHE COLOR	ART.NR.	MM BxTxH MM WxDxH
WEISS WHITE	KNYA900A-CO	900x500x105
MORIER MORIER	KNYA900A-MO	900x500x105
MILANO NUSS MILANO NUT	KNYA900A-NM	900x500x105
BIRKE BIRCH	KNYA900A-BL	900x500x105

SET BEINHALTET DEN KRAWATTENHALTER, DIE AUSZUGSSCHIENE UND DIE AUFNAHMEPLATTE (18 MM SPANPLATTE). BEFESTIGUNG FOLGT DURCH DIE SET LS2KL ODER LS3KL, WELCHES SEPARAT ZU BESTELLEN IST. | SET CONTAINS TIE HOLDER, THE DRAWER SIDE RUNNER AND THE WOOD SIDES (18 MM CHIPBOARD). FIXING THROUGH LS2KL OR LS3KL THAT SHALL BE ORDERED SEPARATELY.

— RASTERBREITE 900 MM | SECTION WIDTH 900 MM

LED-BELEUCHTUNG | LED-LIGHTING

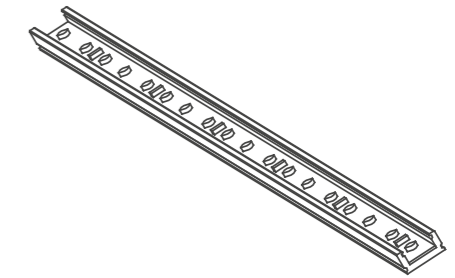
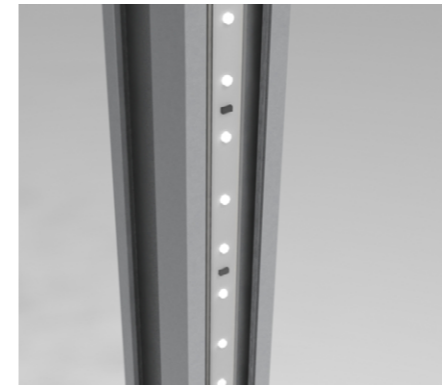

ART.NR.	MM BxTxH MM WxDxH
LED 1000	13x8x1000
LED 2000	13x8x2000

KALTWEISS LED-BELEUCHTUNG. KOMPLETT MONTIERT, FERTIG ZU INSTALLIEREN. | COLD WHITE LED-LIGHTING. ASSEMBLED, READY TO INSTALL.

— SPANNUNG / LEISTUNG 12V – 12,5 W/M | VOLTAGE / POWER: 12V – 12,5 W/M

— NETZTEIL 110/240 V / 12 V | POWER ADAPTER 110/240 V / 12 V

HOME OFFICE TISCH MIT SCHUBLADE | HOME OFFICE DESK WITH DRAWER

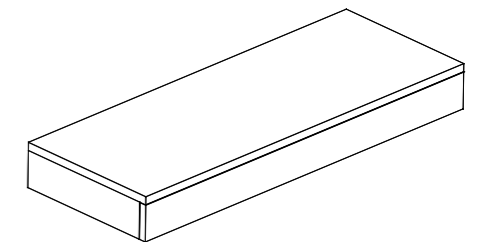

OBERFLÄCHE COLOR	ART.NR.	MM BxTxH MM WxDxH
WEISS WHITE	HO900CO	900x500x150
	HO1320CO	1320x500x150
MORIER MORIER	HO900MO	900x500x150
	HO1320MO	1320x500x150
MILANO NUSS MILANO NUT	HO900NM	900x500x150
	HO1320NM	1320x500x150
BIRKE BIRCH	HO900BL	900x500x150
	HO1320BL	1320x500x150

— DEKOR SPANPLATTE 25 MM, ABS KANTEN 1 MM | DECOR CHIPBOARD 25 MM, ABS EDGE 1 MM

— AUSFÜHRUNG DER SCHUBLADEN | TYPE OF THE DRAWERS:

— TIEFE 500 MM | DEPTH 500 MM

